

metafun xl

Hans Hagen

Contents

Introduction	2
1 Technology	4
2 Text	6
3 Axis	10
4 Outline	12
5 Followtext	15
6 Placeholder	18
7 Arrow	20
8 Shade	23
9 Contour	29
10 Surface	40
11 Mesh	43
12 Function	47
13 Chart	56
14 SVG	65
15 Poisson	67
16 Fonts	71
17 Color	78
18 Lines	84
19 Paths	85
20 Envelopes	112
21 Groups	124
22 Potrace	125
23 Extensions	133
24 Bytemaps	152
25 Noise	174
26 Interface	180
27 Performance	185
28 Whatever	188
29 Oscillate	189
30 Three dimensional surfaces	195
METAPOST syntax	206

Introduction

For quite a while, around since 1996, the integration of MetaPost into ConT_EXt became sort of mature but, it took decades of stepwise refinement to reach the state that we're in now. In this manual I will discuss some of the features that became possible by combining Lua and MetaPost. We already had quite a bit of that for a decade but in 2018, when LuaMetaT_EX showed up a next stage was started.

Before we go into details it is good to summarize the steps that were involved in integrating MetaPost and T_EX in ConT_EXt. It indicates a bit what we had and have to deal with which in turn lead to the interfaces we now have.

Originally, T_EX had no graphic capabilities: it just needed to know dimensions of the graphics and pass some basic information about what to include to the dvi post processor. So, a MetaPost graphic was normally processed outside the current run, resulting in PostScript graphic, that then had to be included. In pdfT_EX there were some more built in options, and therefore the MetaPost code could be processed runtime using some (generic) T_EX macros that I wrote. However, that engine still had to launch MetaPost for each graphic, although we could accumulate them and do that between runs. Immediate processing means that we immediately know the dimensions, while a collective run is faster. In LuaT_EX this all changed to very fast runtime processing, made possible because the MetaPost library is embedded in the engine, a decision that we made early in the project and never regret.

With pdfT_EX the process was managed by the `texexec` ConT_EXt runner but with LuaT_EX it stayed under the control of the current run. In the case of pdfT_EX the actual embedding was done by T_EX macros that interpreted the (relatively simple) PostScript code and turned it into pdf literals. In LuaT_EX that job was delegated to Lua.

When using pdfT_EX with independent MetaPost runs support for special color spaces, transparency, embedded graphics, outline text, shading and more was implemented using specials and special colors where the color served as reference to some special extension. This works quite well. In LuaT_EX the pre- and postscript features, which are properties of picture objects, are used.

In all cases, some information about the current run, for instance layout related information, or color information, has to be passed to the rather isolated MetaPost run. In the case of LuaT_EX (and MkIV) the advantage is that processing optional text happens in the same process so there we don't need to pass information about for instance the current font setup.

In LuaT_EX the MetaPost library has a `runscript` feature, which will call Lua with the given code. This permitted a better integration: we could now ask for specific information (to the T_EX end) instead of passing it from the T_EX end with each run. In LuaMetaT_EX another feature was added: access to the scanners from the Lua end. Although we could already fetch some variables when in Lua this made it possible to extend the MetaPost language in ways not possible before.

Already for a while Alan Braslau and I were working on some new MetaFun code that exploits all these new features. When the scanners came available I sat down and started working on new interfaces and in this manual I will discuss some of these. Some of them are illustrative, others are probably rather useful. The core of what we could call LuaMetaFun (or MetaFun XL when we use the file extension as indicator) is a key-value interface as we have at the T_EX end. This interface relates to ConT_EXt LMTX development and therefore related files have a different suffix: `mpx1`. However, keep in mind that some are just wrappers around regular MetaPost code so you have the full power of traditional MetaPost at hand.

We can never satisfy all needs, so to some extent this manual also demonstrates how to roll out your own code, but for that you also need to peek into the MetaFun source code too. It will take a while for this manual to complete. I also expect other users to come up with solutions, so maybe in the end we will have a collection of modules for specific tasks.

There is some duplication between this manual and the MetaFun manual which is mostly a side effect of some functionality not being present in MkIV and discussing it in the LuaMetaFun manual would be confusing. Also, from an educational point of view it doesn't hurt to read about it twice.

Because Mikael Sundqvist and I both like MetaPost and we work together on improving existing and exploring new features in the engine as well as MetaFun. Some of the examples in this manual result from that. We have a lot of fun working on this and a side effect this manual benefits a lot from our collaboration.

Hans Hagen
Hasselt NL
August 2021 (and beyond)

1 Technology

The MetaPost library that we use in LuaMetaT_EX is a follow up on the library used in LuaT_EX which itself is a follow up on the original MetaPost program that again was a follow up on Don Knuths MetaFont, the natural companion to T_EX.

When we start with John Hobbies MetaPost we see a graphical engine that provides a simple but powerful programming language meant for making graphics, not the freehand kind, but the more systematic ones. The output is PostScript but a simple kind that can easily be converted to pdf.¹ Its output is very accurate and performance is great.

As part of the LuaT_EX development project Taco Hoekwater turned MetaPost into mplib, a downward compatible library where MetaPost became a small program using that library. But there is more: there are (when enabled) backends that produce png or svg, but when used these also add dependencies on moving targets. The library by default uses the so called scaled numbers: floats that internally are long integers. But it can also work in doubles, decimal and binary and especially the last two create a dependency on libraries. It is good to notice that as in the original MetaPost the PostScript output handling is visible all over the source. Also, the way Type1 fonts are handled has been extended, for instance by providing access to shapes.

At some point a Lua interface got added that made it possible to call out to the Lua instance used in LuaT_EX, so the three concepts: T_EX, MetaPost and Lua can combine forces. A snippet of code can be run, and a result can be piped back. Although there is some limited access to MetaPost internals, the normal way to go is by serializing MetaPost data to the Lua end and let MetaPost scan the result using `scantokens`.

The library in LuaMetaT_EX is a bit different. Of course it has the same core graphic engine, but there is no longer a backend. In ConT_EXt MkIV the PostScript (and other) backends were not used anyway because it operates on the exported Lua representation of the result. Combined with the `prescript` and `postscript` features introduced in the library that provides all we need to make interesting extensions to the graphical engine (color, shading, image inclusion, text, etc). The MetaPost font support features are also not used because we need support for OpenType and even in MkII (for pdfT_EX and X₂T_EX) we used a different approach to fonts.

It is for that reason that the library we use in LuaMetaT_EX is a leaner version of its ancestor. As mentioned, there is no backend code, only the Lua export, which saves a lot, and there are no traces of font support left, which also drops many lines of code. We forget about the binary number model because it needs a large library that also occasionally changes, but one can add it if needed. This means that there are no dependencies except for decimal but that library is relatively small and doesn't change at all. It also means that the resulting mplib library is much smaller, but it's still a substantial component in LuaMetaT_EX. Internally I use the future version number 3. The original MetaPost program is version 1, so the library got version 2, and that one basically being frozen (it's in bug-fix mode) means that it will stick to that.

Another difference is that from the Lua end one has access to several scanners and also has possibilities to efficiently push back results to the engine. Running scripts can also be done more efficient. This permits a rather efficient (in terms of performance and memory usage) way to extend the language and

¹ For that purpose I wrote a converter in the T_EX language for pdfT_EX, and even within the limitations of T_EX at that time (fonts, number of registers, memory) it worked out quite well.

add for instance key/value based interfaces. There are some more additions, like for instance pre- and postscripts to clip, boundary and group objects. Internals can be numeric, string and boolean. One can use utf input although that has also be added to the ancestor. Some redundant internal input/output remapping has been removed and we are more tolerant to newlines in return values from Lua. Error messages have been normalized, internal documentation cleaned up a bit. A few anomalies have been fixed too. All in- and output is now under Lua control. Etcetera. The (now very few) source files are still cweb files but the conversion to C is done with a Lua script that uses (surprise) the LuaMetaTeX engine as Lua processor. This give a bit nicer C output for when we view it in e.g. Visual Studio too (normally the cweb output is not meant to be seen by humans).

Keep in mind that it's still MetaPost with all it provided, but some has to be implemented in macros or in Lua via callbacks. The simple fact that the original library is the standard and is also the core of MetaPost most of these changes and additions cannot be backported to the original, but that is no big deal. The advantage is that we can experiment with new features without endangering users outside the ConTeXt bubble. The same is true for the Lua interface, which already is upgraded in many aspects.

2 Text

2.1 Typesetting text

The MetaFun `texttext` command normally can do the job of typesetting a text snippet quite well.

```
\startMPcode
  fill fullcircle xyscaled (8cm,1cm) withcolor "darkred" ;
  draw texttext("\bf This is text A") withcolor "white" ;
\stopMPcode
```

We get:



This is text A

You can use regular ConT_EXt commands, so this is valid:

```
\startMPcode
  fill fullcircle xyscaled (8cm,1cm) withcolor "darkred" ;
  draw texttext("\framed{\bf This is text A}") withcolor "white" ;
\stopMPcode
```

Of course you can as well draw a frame in MetaPost but the `\framed` command has more options, like alignments.



This is text A

Here is a variant using the MetaFun interface:

```
\startMPcode
  fill fullcircle xyscaled (8cm,1cm) withcolor "darkred" ;
  draw lmt_text [
    text = "This is text A",
    color = "white",
    style = "bold"
  ] ;
\stopMPcode
```

The outcome is more or less the same:



This is text A

Here is another example. The `format` option is actually why this command is provided.

```
\startMPcode
  fill fullcircle xyscaled (8cm,1cm) withcolor "darkred" ;
  draw lmt_text [
```

```

text    = decimal 123.45678,
color   = "white",
style   = "bold",
format  = "@0.3F",
] ;

```

\stopMPcode

123.457

The following parameters can be set:

name	type	default	comment
offset	numeric	0	
strut	string	auto	adapts the dimensions to the font (yes uses the the default strut)
style	string		
color	string		
text	string		
anchor	string		one of these lft, urt like anchors
format	string		a format specifier using @ instead of a percent sign
position	pair	origin	
trace	boolean	false	

The next example demonstrates the positioning options:

\startMPcode

```

fill fullcircle xyscaled (8cm,1cm) withcolor "darkblue" ;
fill fullcircle scaled .5mm withcolor "white" ;
draw lmt_text [
  text    = "left",
  color   = "white",
  style   = "bold",
  anchor  = "lft",
  position = (-1mm,2mm),
] ;
draw lmt_text [
  text    = "right",
  color   = "white",
  style   = "bold",
  anchor  = "rt",
  offset  = 3mm,
] ;

```

\stopMPcode

left. right

2.2 Strings

Those familiar with T_EX probably know that there's something called catcodes. These are properties that you assign to characters and that gives them some meaning, like regular letters, other characters, spaces, but also escape character (the backslash) or math shift (the dollar). Control over catcodes is what makes for instance verbatim possible.

We show a few possibilities and start by defining a macro:

```
\def\foo{x}
```

```
\framed\bgroup
  \startMPcode
    interim catcoderegime := vrbcatcoderegime ;
    draw texttext("stream $\string\foo$") withcolor "darkred" ;
  \stopMPcode
\egroup
```

```
stream $\foo$
```

```
\framed\bgroup
  \startMPcode
    draw texttext("stream $\foo$") withcolor "darkblue" ;
  \stopMPcode
\egroup
```

```
stream x
```

```
\framed\bgroup
  \startMPcode
    interim catcoderegime := vrbcatcoderegime ;
    draw texttext(stream "!" $\string\foo$) withcolor "darkgreen" ;
  \stopMPcode
\egroup
```

```
stream "!" $\foo$
```

```
\framed\bgroup
  \startMPcode
    draw texttext(stream "!" $\foo$) withcolor "darkyellow" ;
  \stopMPcode
\egroup
```

```
stream "!" x
```

```
\framed\bgroup
  \startMPcode
    draw texttext(\btx stream "!" $\string\foo$\etx) withcolor "darkgreen" ;
  \stopMPcode
```

`\egroup`

```
stream "!" x
```

The `vrbcodesregime` switches to a verbatim catcode regime so the dollars remain dollars. But because we do expand control sequences we have to put `\string` in front.

The (expandable) `\bt` and `\et` commands are aliases for the control characters `0x02` and `0x03`. These are valid string fences in LuaMetaTeX's MetaPost and thereby permit embedding of the double quotes.

3 Axis

The axis macro is the result of one of the first experiments with the key/value interface in MetaFun. Let's show a lot in one example:

```
\startMPcode
  draw lmt_axis [
    sx = 5mm, sy = 5mm,
    nx = 20,  ny = 10,
    dx = 5,   dy = 2,
    tx = 10,  ty = 10,

    list = {
      [
        connect = true,
        color   = "darkred",
        close   = true,
        points  = { (1, 1), (15, 8), (2, 10) },
        texts   = { "segment 1", "segment 2", "segment 3" }
      ],
      [
        connect = true,
        color   = "darkgreen",
        points  = { (2, 2), (4, 1), (10, 3), (16, 8), (19, 2) },
        labels  = { "a", "b", "c", "d", "e" }
      ],
      [
        connect = true,
        color   = "darkblue",
        close   = true,
        points  = { (5, 3), (8, 8), (16, 1) },
        labels  = { "1", "2", "3" }
      ]
    },

    ] withpen pencircle scaled 1mm ;
\stopMPcode
```

This macro will probably be extended at some point.

name	type	default	comment
nx	numeric	1	
dx	numeric	1	
tx	numeric	0	
sx	numeric	1	
startx	numeric	0	
ny	numeric	1	
dy	numeric	1	

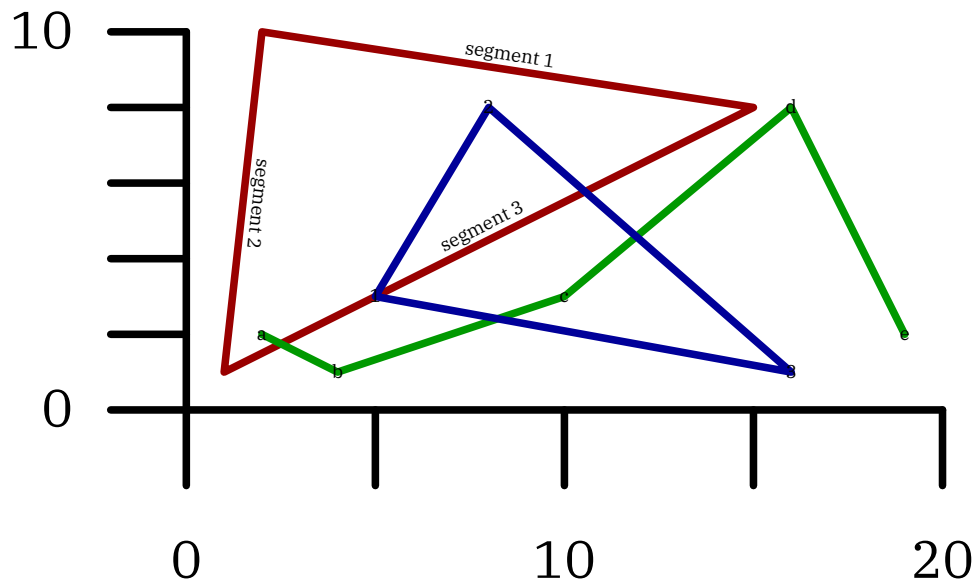

Figure 3.1

ty	numeric	0
sy	numeric	1
starty	numeric	0

samples	list
list	list
connect	boolean false
list	list
close	boolean false
samplecolors	list
axiscolor	string
textcolor	string

4 Outline

In a regular text you can have outline characters by setting a (pseudo) font feature but sometimes you want to play a bit more with this. In MetaFun we always had that option. In MkII we call `pstoedit` to turn text into outlines, in MkIV we do that by manipulating the shapes directly. And, as with some other extensions, in LMTX a new interface has been added, but the underlying code is the same as in MkIV.

In figure 4.1 we see two examples:

```
\startMPcode
draw lmt_outline [
  text      = "hello"
  kind      = "draw",
  drawcolor = "darkblue",
] xsize .45TextWidth ;
\stopMPcode
```

and

```
\startMPcode
draw lmt_outline [
  text      = "hello",
  kind      = "both",
  fillcolor  = "middlegray",
  drawcolor  = "darkgreen",
  rulethickness = 1/5,
] xsize .45TextWidth ;
\stopMPcode
```

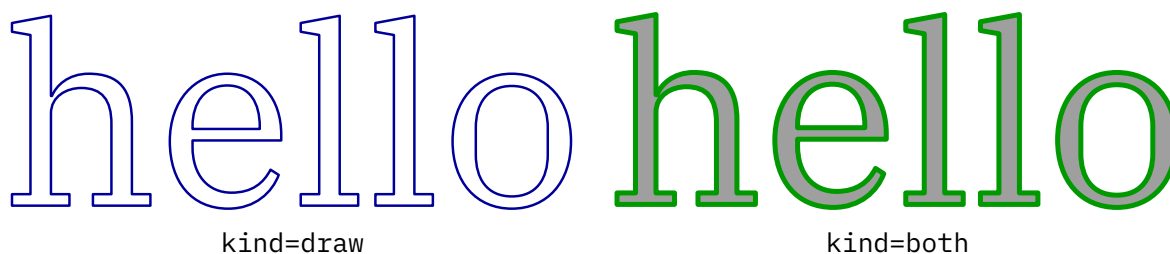

Figure 4.1 Drawing and/or filling an outline.

Normally the fill ends up below the draw but we can reverse the order, as in figure 4.2, where we coded the leftmost example as:

```
\startMPcode
draw lmt_outline [
  text      = "hello",
  kind      = "reverse",
  fillcolor  = "darkred",
  drawcolor  = "darkblue",
  rulethickness = 1/2,
] xsize .45TextWidth ;
\stopMPcode
```

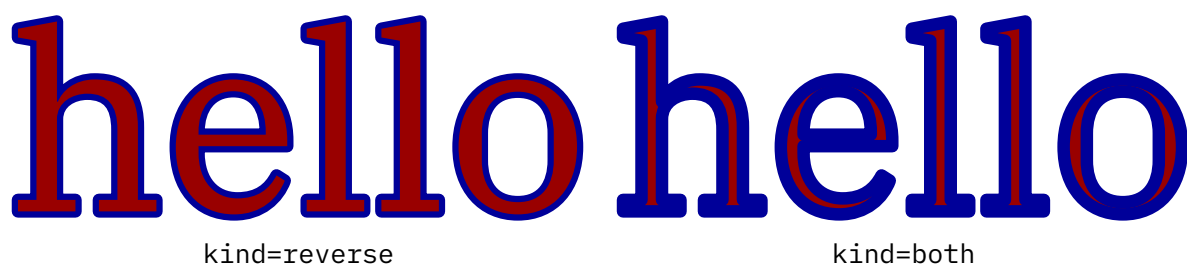

Figure 4.2 Reversing the order of drawing and filling.

It is possible to fill and draw in one operation, in which case the same color is used for both, see figure 4.3 for an example for this. This is a low level optimization where the shape is only output once.



Figure 4.3 Combining a fill with a draw in the same color.

This interface is much nicer than the one where each variant (the parameter `kind` above) had its own macro due to the need to group properties of the outline and fill. Let's show some more:

```
\startMPcode
  draw lmt_outline [
    text      = "\obeydiscretionaries\samplefile{tufte}",
    align     = "normal",
    kind      = "draw",
    drawcolor = "darkblue",
  ] xsize TextWidth ;
\stopMPcode
```

In this case we feed the text into the `\framed` macro so that we get a properly aligned paragraph of text, as demonstrated in figure 4.4 and ???. If you want more trickery you can of course use any ConT_EXt command (including `\framed` with all kind of options) in the text.

We thrive in informationathick worlds because of our marvelous and everyday capacity to select, edit, single out, structure, highlight, group, pair, merge, harmonize, synthesize, focus, organize, condense, reduce, boil down, choose, categorize, catalog, classify, list, abstract, scan, look into, idealize, isolate, discriminate, distinguish, screen, pigeonhole, pick over, sort, integrate, blend, inspect, filter, lump, skip, smooth, chunk, average, approximate, cluster, aggregate, outline, summarize, itemize, review, dip into, flip through, browse, glance into, leaf through, skim, refine, enumerate, glean, synopsisize, winnow the wheat from the chaff and separate the sheep from the goats.

Figure 4.4 Outlining a paragraph of text.

```
\startMPcode
  draw lmt_outline [
    text      = "\obeydiscretionaries\samplefile{ward}",
    align     = "normal,tolerant",
```

```

    style      = "bold",
    width      = 10cm,
    kind       = "draw",
    drawcolor  = "darkblue",
] x sized TextWidth ;

```

\stopMPcode

The Earth, as a habitat for animal life, is in old age and has a fatal illness. Several, in fact. It would be happening whether humans had ever evolved or not. But our presence is like the effect of an old-age patient who smokes many packs of cigarettes per day—and we humans are the cigarettes.

Figure 4.5 Outlining a paragraph of text with a specific width.

We summarize the parameters:

name	type	default	comment
text	string		
kind	string	draw	One of draw, fill, both, reverse and fillup.
fillcolor	string		
drawcolor	string		
rulethickness	numeric	1/10	
align	string		
style	string		
width	numeric		

Here is a bonus:

```

\startMPcode
  draw lmt_outline [
    kind = "outline",
    text = "\bf To foo or to bar, that's the question.",
  ] x sized TextWidth
    withshademethod "linear"
    withshadedirection down
    withshadecolors ("lightred","lightblue")
  ;
\stopMPcode

```

Here we get a path back instead of a picture with multiple elements:

To foo or to bar, that's the question.

5 Followtext

Typesetting text along a path started as a demo of communication between $\text{T}_{\text{E}}\text{X}$ and MetaPost in the early days of MetaFun. In the meantime the implementation has been modernized a few times and the current implementation feels okay, especially now that we have a better user interface. Here is an example:

```
\startMPcode{doublefun}  
  draw lmt_followtext [  
    text    = "How well does it work {\bf 1}! ",  
    path    = fullcircle scaled 4cm,  
    trace   = true,  
    spread  = true,  
  ] ysize 5cm ;  
\stopMPcode
```

Here is the same example but with the text in the reverse order. The results of both examples are shown in figure 5.1.

```
\startMPcode{doublefun}  
  draw lmt_followtext [  
    text    = "How well does it work {\bf 2}! ",  
    path    = fullcircle scaled 4cm,  
    trace   = true,  
    spread  = false,  
    reverse = true,  
  ] ysize 5cm ;  
\stopMPcode
```

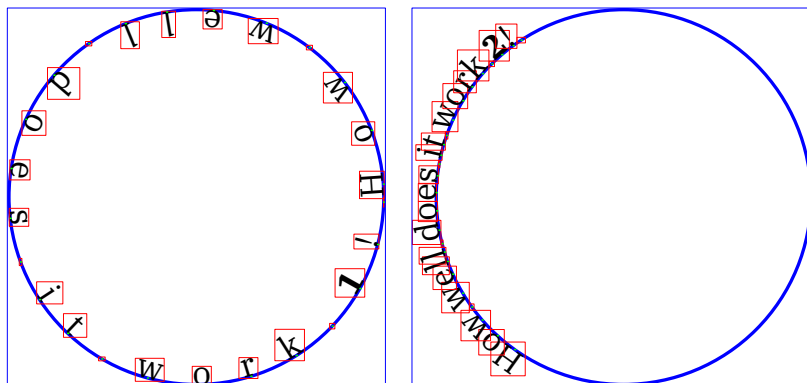

Figure 5.1

There are not that many options. One is `autoscale` which makes the shape and text match. Figure 5.2 shows what happens.

```
\startMPcode{doublefun}  
  draw lmt_followtext [  
    text      = "How well does it work {\bf 3}! ",  
    trace     = true,  
    autoscale = "yes"  
  ]
```

```

] ysize 5cm ;
\stopMPcode

\startMPcode{doublefun}
draw lmt_followtext [
text      = "How well does it work {\bf 4}! ",
path      = fullcircle scaled 2cm,
trace     = true,
autoscaleup = "max"
] ysize 5cm ;
\stopMPcode

```

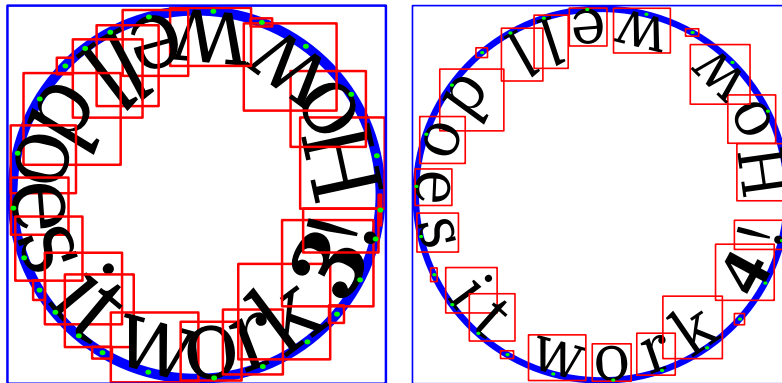

Figure 5.2

You can use quite strange paths, like the one show in figure 5.3. Watch the parenthesis around the path. this is really needed in order for the scanner to pick up the path (otherwise it sees a pair).

```

\startMPcode{doublefun}
draw lmt_followtext [
text      = "\samplefile {zapf}",
path      = ((3,0) .. (1,0) .. (5,0) .. (2,0) .. (4,0) .. (3,0)),
autoscaleup = "max"
] xsize TextWidth ;
\stopMPcode

```

The small set of options is:

name	type	default	comment
text	string		
spread	string	true	
trace	numeric	false	
reverse	numeric	false	
autoscaleup	numeric	no	
autoscaledown	string	no	
path	string	(fullcircle)	

Coming back to the use of typefaces in electronic publishing: many of the new typographers receive their knowledge and information about the rules of typography from books, from computer magazines or the instruction manuals which they get with the purchase of a PC or software. There is not so much basic instruction as of now, as there was in the old days, showing the differences between good and bad typographic design.

Many people are just fascinated by their PC's tricks, and think that a widely-praised program, called up on the screen, will make everything automatic from now on.

Figure 5.3

6 Placeholder

Placeholders are an old ConT_EXt features and have been around since we started using MetaPost. They are used as dummy figure, just in case one is not (yet) present. They are normally activated by loading a MetaFun library:

```
\useMPLibrary[dum]
```

Just because it could be done conveniently, placeholders are now defined at the MetaPost end instead of as useable MetaPost graphic at the T_EX end. The variants and options are demonstrated using side floats.



Figure 6.1

```
\startMPcode
  lmt_placeholder [
    width      = 4cm,
    height     = 3cm,
    color      = "red",
    alternative = "circle".
  ] ;
\stopMPcode
```

In addition to the traditional random circle we now also provide rectangles and triangles. Maybe some day more variants will show up.



Figure 6.2

```
\startMPcode
  lmt_placeholder [
    width      = 4cm,
    height     = 3cm,
    color      = "green",
    alternative = "square".
  ] ;
\stopMPcode
```

Here we set the colors but in the image placeholder mechanism we cycle through colors automatically. Here we use primary, rather dark, colors.

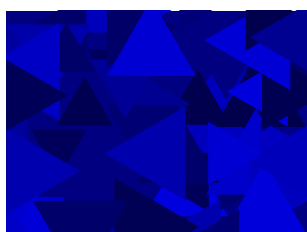

Figure 6.3

```
\startMPcode
  lmt_placeholder [
    width      = 4cm,
    height     = 3cm,
    color      = "blue",
    alternative = "triangle".
  ] ;
\stopMPcode
```

If you want less dark colors, the reduction parameter can be used to interpolate between the given color and white; its value is therefore a value between zero (default) and 1 (rather pointless as it produces white).

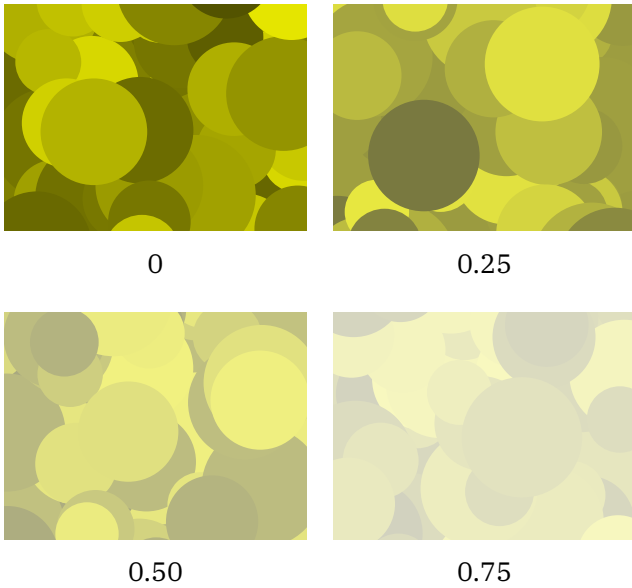

Figure 6.4

We demonstrate this with four variants, all circles. Of course you can also use lighter colors, but this option was needed for the image placeholders anyway.

```

\startMPcode
  lmt_placeholder [
    width      = 4cm,
    height     = 3cm,
    color      = "yellow",
    alternative = "circle".
    reduction  = 0.25,
  ] ;
\stopMPcode

```

There are only a few possible parameters. As you can see, proper dimensions need to be given because the defaults are pretty small.

name	type	default	comment
color	string	red	
width	numeric	1	
height	numeric	1	
reduction	numeric	0	
alternative	string	circle	

7 Arrow

Arrows are somewhat complicated because they follow the path, are constructed using a pen, have a fill and draw, and need to scale. One problem is that the size depends on the pen but the pen normally is only known afterwards.

To some extent MetaFun can help you with this issue. In figure 7.1 we see some variants. The definitions are given below:

```
\startMPcode
draw lmt_arrow [
  path = (fullcircle scaled 3cm),
]
  withpen pencircle scaled 2mm
  withcolor "darkred" ;
\stopMPcode

\startMPcode
draw lmt_arrow [
  path = (fullcircle scaled 3cm),
  length = 8,
]
  withpen pencircle scaled 2mm
  withcolor "darkgreen" ;
\stopMPcode

\startMPcode
draw lmt_arrow [
  path = (fullcircle scaled 3cm rotated 145),
  pen = (pencircle xscaled 4mm yscaled 2mm rotated 45),
]
  withpen pencircle xscaled 1mm yscaled .5mm rotated 45
  withcolor "darkblue" ;
\stopMPcode

\startMPcode
pickup pencircle xscaled 2mm yscaled 1mm rotated 45 ;
draw lmt_arrow [
  path = (fullcircle scaled 3cm rotated 45),
  pen = "auto",
]
  withcolor "darkyellow" ;
\stopMPcode
```

There are some options that influence the shape of the arrowhead and its location on the path. You can for instance ask for two arrowheads:

```
\startMPcode
  pickup pencircle scaled 1mm ;
```

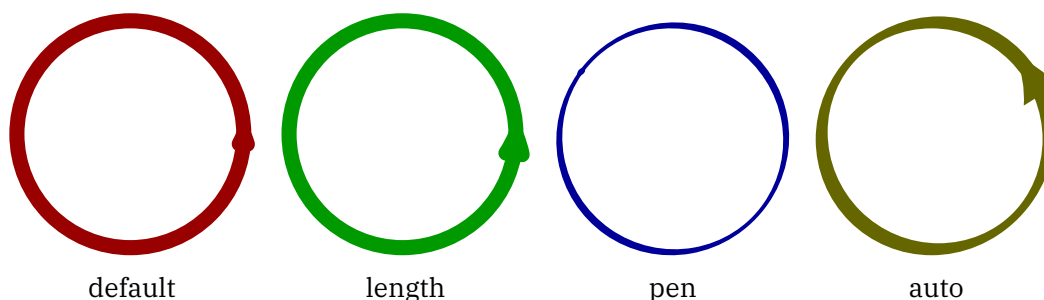

Figure 7.1

```

draw lmt_arrow [
  pen      = "auto",
  location = "both"
  path     = fullcircle scaled 3cm rotated 90,
] withcolor "darkgreen" ;

```

\stopMPcode

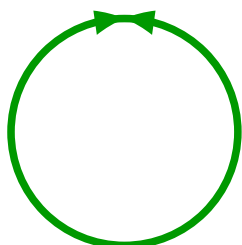

The shape can also be influenced although often this is not that visible:

\startMPcode

```

pickup pencircle scaled 1mm ;
draw lmt_arrow [
  kind      = "draw",
  pen       = "auto",
  penscale  = 4,
  location  = "middle",
  alternative = "curved",
  path      = fullcircle scaled 3cm,
] withcolor "darkblue" ;

```

\stopMPcode



The location can also be given as percentage, as this example demonstrates. Watch how we draw only arrow heads:

\startMPcode

```

pickup pencircle scaled 1mm ;
for i = 0 step 5 until 100 :
  draw lmt_arrow [
    alternative = "dimpled",
    pen         = "auto",
    location    = "percentage",
    percentage  = i,
    dimple      = (1/5 + i/200),
    headonly    = (i = 0),
    path        = fullcircle scaled 3cm,
  ] withcolor "darkyellow" ;
endfor ;
\stopMPcode

```



The supported parameters are:

name	type	default	comment
path	path		
pen	path		
kind	string	auto	fill or draw
dimple	numeric	1/5	
scale	numeric	3/4	
penscale	numeric	3	
length	numeric	4	
angle	numeric	45	
location	string	end	end, middle or both
alternative	string	normal	normal, dimpled or curved
percentage	numeric	50	
headonly	boolean	false	

8 Shade

8.1 Shading operators

see *MetaFun manual*.

8.2 Shading interface.

This interface is still experimental!

Shading is complex. We go from one color to another on a continuum either linear or circular. We have to make sure that we cover the whole shape and that means that we have to guess a little, although one can influence this with parameters. It can involve a bit of trial and error, which is more complex than using a graphical user interface but this is the price we pay. It goes like this:

```
\startMPcode
definecolor [ name = "MyColor3", r = 0.22, g = 0.44, b = 0.66 ] ;
definecolor [ name = "MyColor4", r = 0.66, g = 0.44, b = 0.22 ] ;

draw lmt_shade [
  path      = fullcircle scaled 4cm,
  direction = "right",
  domain    = { 0, 2 },
  colors    = { "MyColor3", "MyColor4" },
] ;

draw lmt_shade [
  path      = fullcircle scaled 3cm,
  direction = "left",
  domain    = { 0, 2 },
  colors    = { "MyColor3", "MyColor4" },
] shifted (45mm,0) ;

draw lmt_shade [
  path      = fullcircle scaled 5cm,
  direction = "up",
  domain    = { 0, 2 },
  colors    = { "MyColor3", "MyColor4" },
] shifted (95mm,0) ;

draw lmt_shade [
  path      = fullcircle scaled 1cm,
  direction = "down",
  domain    = { 0, 2 },
  colors    = { "MyColor3", "MyColor4" },
] shifted (135mm,0) ;
\stopMPcode
```

Normally this is good enough as demonstrated in figure 8.1 because we use shades as backgrounds. In the case of a circular shade we need to tweak the domain because guessing doesn't work well.

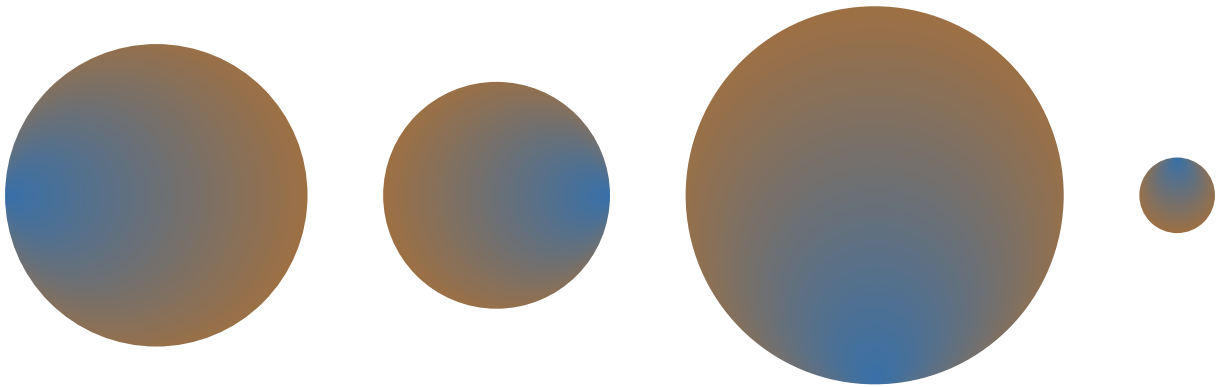

Figure 8.1 Simple circular shades.

```

\startMPcode
draw lmt_shade [
  path      = fullsquare scaled 4cm,
  alternative = "linear",
  direction  = "right",
  colors     = { "MyColor3", "MyColor4" },
] ;

draw lmt_shade [
  path      = fullsquare scaled 3cm,
  direction  = "left",
  alternative = "linear",
  colors     = { "MyColor3", "MyColor4" },
] shifted (45mm,0) ;

draw lmt_shade [
  path      = fullsquare scaled 5cm,
  direction  = "up",
  alternative = "linear",
  colors     = { "MyColor3", "MyColor4" },
] shifted (95mm,0) ;

draw lmt_shade [
  path      = fullsquare scaled 1cm,
  direction  = "down",
  alternative = "linear",
  colors     = { "MyColor3", "MyColor4" },
] shifted (135mm,0) ;
\stopMPcode

```

The direction relates to the boundingbox. Instead of a keyword you can also give two values, indicating points on the boundingbox. Because a boundingbox has four points, the up direction is equivalent to $\{0.5, 2.5\}$.

The parameters center, factor, vector and domain are a bit confusing but at some point the way they were implemented made sense, so we keep them as they are. The center moves the center of the path that is used as anchor for one color proportionally to the bounding box: the given factor is multiplied by half the width and height.



Figure 8.2 Simple rectangular shades.

```

\startMPcode
draw lmt_shade [
  path      = fullcircle scaled 5cm,
  domain    = { .2, 1.6 },
  center    = { 1/10, 1/10 },
  direction = "right",
  colors    = { "MyColor3", "MyColor4" },
  trace     = true,
] ;
\stopMPcode

```

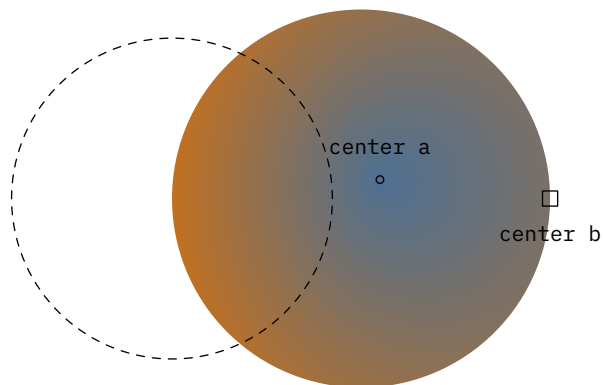

Figure 8.3 Moving the centers.

A vector takes the given points on the path as centers for the colors, see figure 8.4.

```

\startMPcode
draw lmt_shade [
  path      = fullcircle scaled 5cm,
  domain    = { .2, 1.6 },
  vector    = { 2, 4 },
  direction = "right",
  colors    = { "MyColor3", "MyColor4" },
  trace     = true,
] ;
\stopMPcode

```

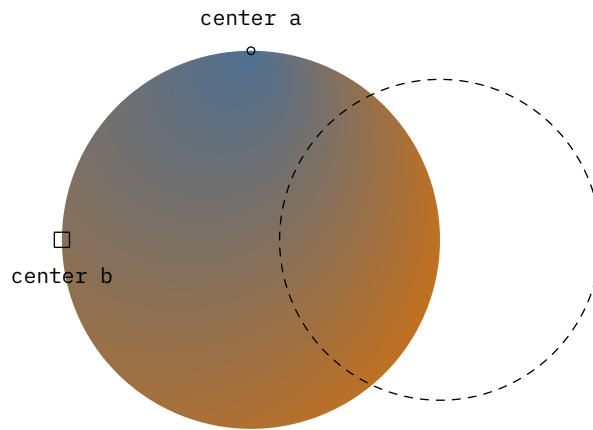

Figure 8.4 Using a vector (points).

Messing with the radius in combination with the previously mentioned domain is really trial and error, as seen in figure 8.5.

```

\startMPcode
draw lmt_shade [
  path      = fullcircle scaled 5cm,
  domain    = { 0.5, 2.5 },
  radius    = { 2cm, 6cm },
  direction = "right",
  colors    = { "MyColor3", "MyColor4" },
  trace     = true,
] ;
\stopMPcode

```

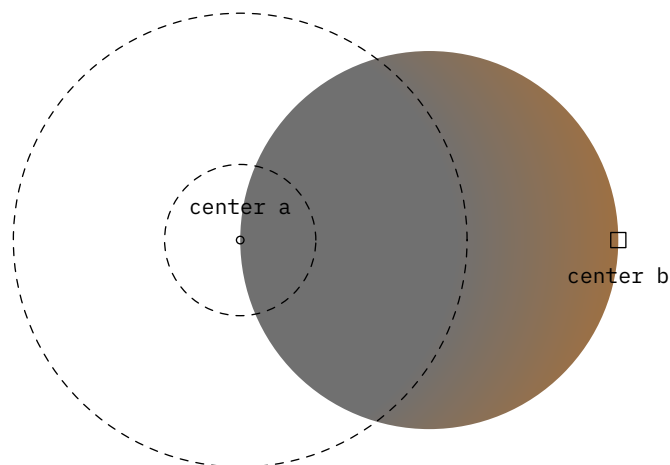

Figure 8.5 Tweaking the radius.

But actually the radius used alone works quite well as shown in figure 8.6.

```

\startMPcode
draw lmt_shade [
  path      = fullcircle scaled 5cm,
  colors    = { "red", "green" },
  trace     = true,
] ;

```

```

draw lmt_shade [
  path      = fullcircle scaled 5cm,
  colors    = { "red", "green" },
  radius    = 2.5cm,
  trace     = true,
] shifted (6cm,0) ;

```

```

draw lmt_shade [
  path      = fullcircle scaled 5cm,
  colors    = { "red", "green" },
  radius    = 2.0cm,
  trace     = true,
] shifted (12cm,0) ;

```

```
\stopMPcode
```

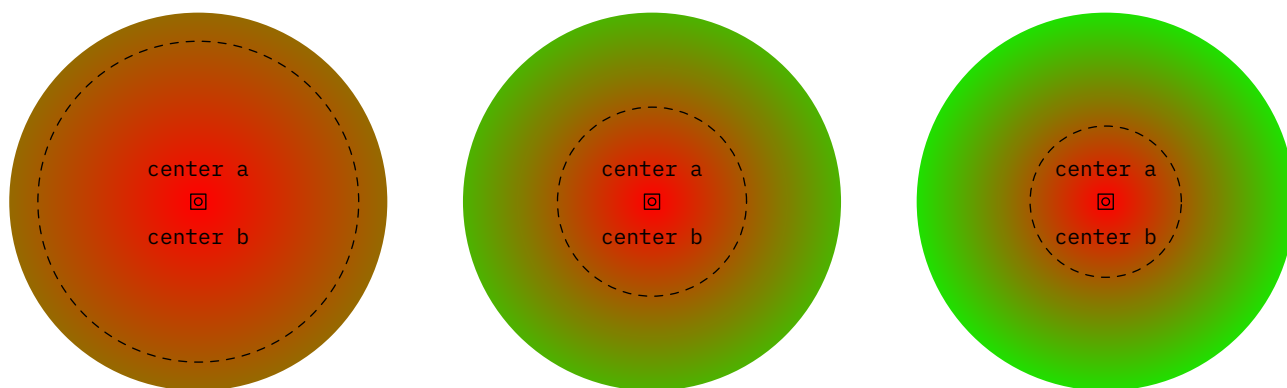

Figure 8.6 Just using the radius.

name	type	default	comment
alternative	string	circular	or linear
path	path		
trace	boolean	false	
domain	set of numerics		
radius	numeric		
factor	set of numerics		
origin	numeric		
vector	pair		
colors	set of pairs		
center	set of numerics		
direction	string		up, down, left, right
	set of numerics		two points on the boundingbox

8.3 Patterns

Instead using a shade one can use a pattern which is basically a fill with a repeated image. Here are some examples:

```

\startMPcode
draw
  (
    (fulldiamond xscaled 8cm yscaled 5cm randomizedcontrols 10mm) && reverse
    (fulldiamond xscaled 6cm yscaled 3cm randomizedcontrols 10mm) && cycle
  )
  withpattern image (fill fullcircle scaled 2mm withcolor "darkyellow" ;)
;
\stopMPcode

```

The image macro produces a picture that is then used for the filling:

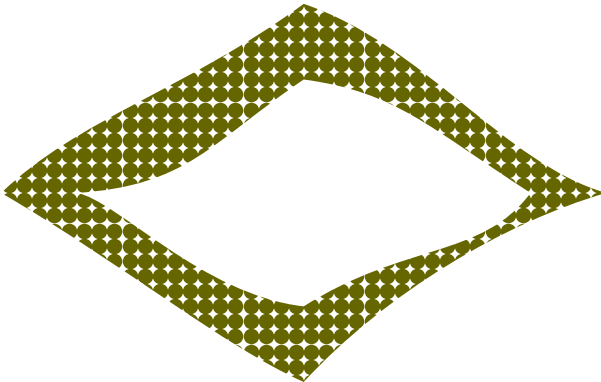

That image can also be an (external) figure:

Of course one needs to find a suitable image for this, but here we just use one of the test figures:

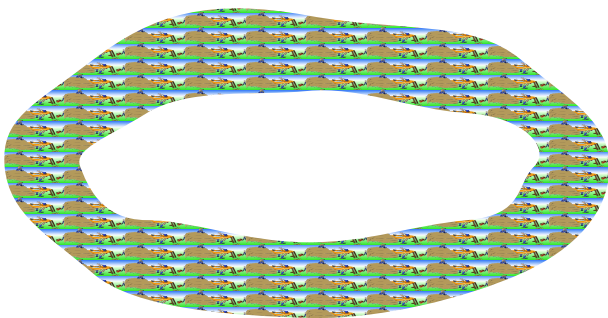

```

\startMPcode
draw
  (
    (fullcircle xscaled 8cm yscaled 4cm randomizedcontrols 5mm) && reverse
    (fullcircle xscaled 6cm yscaled 2cm randomizedcontrols 5mm) && cycle
  )
  withpattern image (draw figure "hacker.jpg" ;)
  withpatternscales (1/10,1/20)
;
\stopMPcode

```

8.4 Luminance

Todo: groups and such.

9 Contour

This feature started out as experiment triggered by a request on the mailing list. In the end it was a nice exploration of what is possible with a bit of Lua. In a sense it is more subsystem than a simple MetaPost macro because quite some Lua code is involved and more might be used in the future. It's part of the fun.

A contour is a line through equivalent values z that result from applying a function to two variables x and y . There is quite a bit of analysis needed to get these lines. In MetaFun we currently support three methods for generating a colorful background and three for putting lines on top:

One solution is to use the the isolines and isobands methods are described on the marching squares page of wikipedia:

https://en.wikipedia.org/wiki/Marching_squares

This method is relative efficient as we don't do much optimization, simply because it takes time and the gain is not that much relevant. Because we support filling of multiple curves in one go, we get efficient paths anyway without side effects that normally can occur from many small paths alongside. In these days of multi megabyte movies and sound clips a request of making a pdf file small is kind of strange anyway. In practice the penalty is not that large.

As background we can use a bitmap. This method is also quite efficient because we use indexed colors which results in a very good compression. We use a simple mapping on a range of values.

A third method is derived from the one that is distributed as C source file at:

<https://physiology.arizona.edu/people/secomb/contours>
<https://github.com/secomb/GreensV4>

We can create a background image, which uses a sequence of closed curves². It can also provide two variants of lines around the contours (we tag them shape and shade). It's all a matter of taste. In the meantime I managed to optimize the code a bit and I suppose that when I buy a new computer (the code was developed on an 8 year old machine) performance is probably acceptable.

In order of useability you can think of isoband (band) with isolines (cell), bitmap (bitmap) with isolines (cell) and finally shapes (shape) with edges (edge). But let's start with a couple of examples.

```
\startMPcode{doublefun}
  draw lmt_contour [
    xmin = 0, xmax = 4*pi, xstep = .05,
    ymin = -6, ymax = 6,   ystep = .05,

    levels      = 7,
    height      = 5cm,
    preamble    = "local sin, cos = math.sin, math.cos",
    function    = "cos(x) + sin(y)",
    background  = "bitmap",
    foreground  = "edge",
```

² I have to figure out how to improve it a bit so that multiple path don't get connected.

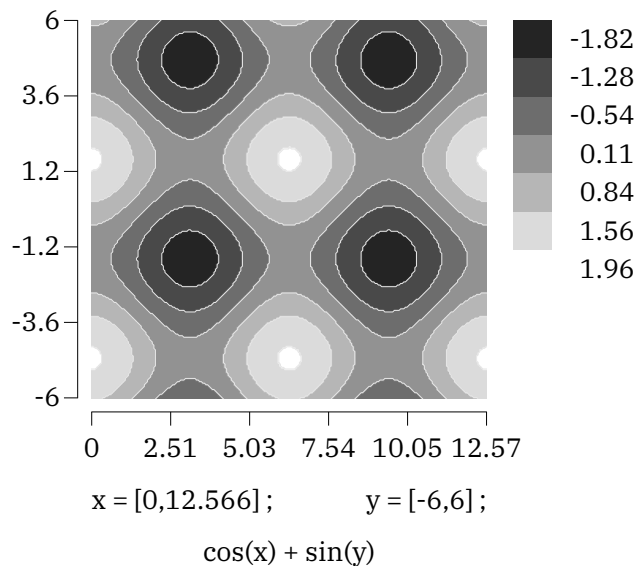

Figure 9.1

```

linewidth = 1/2,
cache     = true,
] ;
\stopMPcode

```

In figure 9.1 we see the result. There is a black and white image generated and on top of that we see lines. The step determines the resolution of the image. In practice using a bitmap is quite okay and also rather efficient: we use an indexed colorspace and, as already was mentioned, because the number of colors is limited such an image compresses well. A different rendering is seen in figure 9.2 where we use the shape method for the background. That method creates outlines but is much slower, and when you use a high resolution (small step) it can take quite a while to identify the shapes. This is why we set the cache flag.

```

\startMPcode{doublefun}
draw lmt_contour [
  xmin = 0, xmax = 4*pi, xstep = .10,
  ymin = -6, ymax = 6,   ystep = .10,

  levels      = 7,
  preamble    = "local sin, cos = math.sin, math.cos",
  function    = "cos(x) - sin(y)",
  background  = "shape",
  foreground  = "shape",
  linewidth   = 1/2,
  cache      = true,
] ;
\stopMPcode

```

We mentioned colorspace but haven't seen any color yet, so let's set some in figure 9.3. Two variants are shown: a background shape with foreground shape and a background bitmap with a foreground edge. The bitmap renders quite fast, definitely when we compare with the shape, while the quality is as good at this size.

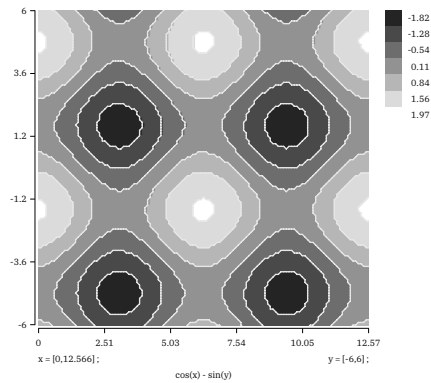

Figure 9.2

```

\startMPcode{doublefun}
  draw lmt_contour [
    xmin = -10, xmax = 10, xstep = .1,
    ymin = -10, ymax = 10, ystep = .1,

    levels      = 10,
    height      = 7cm,
    color       = "shade({1/2,1/2,0},{0,0,1/2})",
    function    = "x^2 + y^2",
    background  = "shape",
    foreground  = "shape",
    linewidth   = 1/2,
    cache      = true,
  ] x sized .45TextWidth ;
\stopMPcode

```

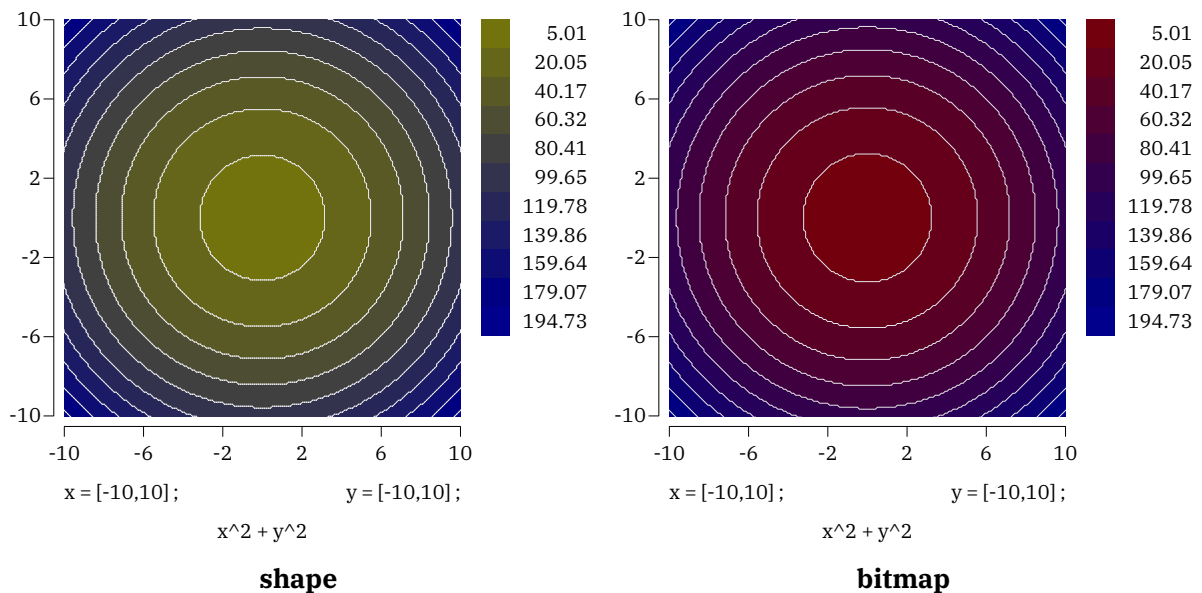

Figure 9.3

We use the doublefun instance because we need to be sure that we don't run into issues with scaled numbers, the default model in MetaPost. The function that gets passed is *not* using MetaPost but Lua, so basically you can do very complex things. Here we directly pass code, but you can for instance also do this:

```

\startluacode
  function document.MyContourA(x,y)
    return x^2 + y^2
  end
\stopluacode

```

and then `function = "document.MyContourA(x,y)"`. As long as the function returns a valid number we're okay. When you pass code directly you can use the `preamble` key to set local shortcuts. In the previous examples we took `sin` and `cos` from the `math` library but you can also roll out your own functions and/or use the more elaborate `xmath` library. The `color` parameter is also a function, one that returns one or three arguments. In the next example we use `lin` to calculate a fraction of the current level and total number of levels.

```

\startMPcode{doublefun}
  draw lmt_contour [
    xmin = -3, xmax = 3, xstep = .01,
    ymin = -1, ymax = 1, ystep = .01,

    levels      = 10,
    default     = .5,
    height      = 5cm,
    function    = "x^2 + y^2 + x + y/2",
    color       = "lin(1), 0, 1/2",
    background  = "bitmap"
    foreground  = "none",
    cache      = true,
  ] x sized TextWidth ;
\stopMPcode

```

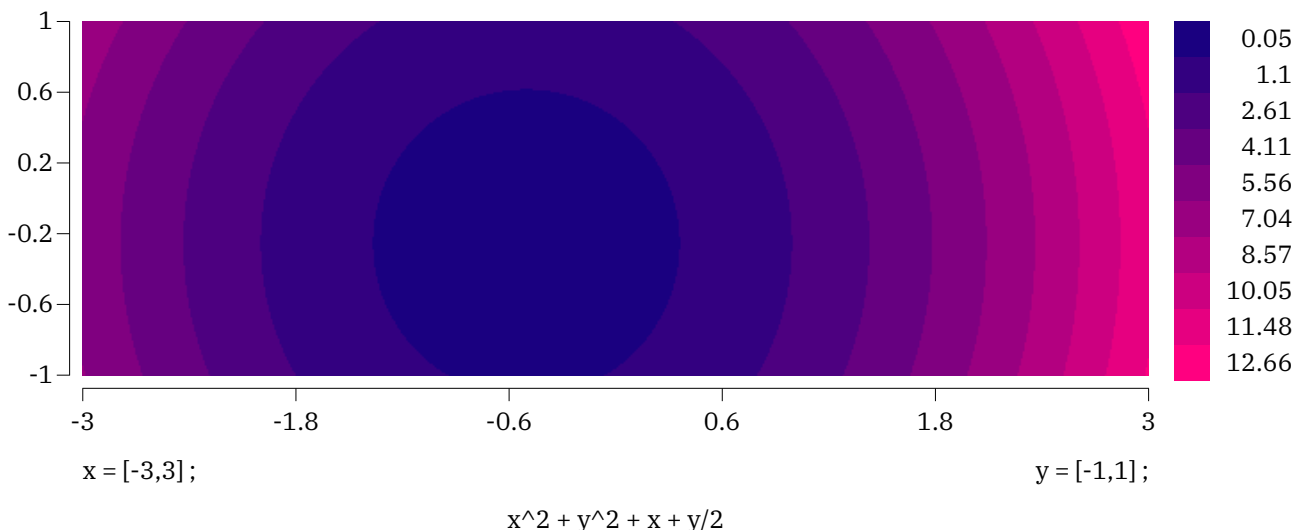

Figure 9.4

Instead of a `bitmap` we can use an `isoband`, which boils down to a set of tiny shapes that make up a bigger one. This is shown in figure 9.5.

```

\startMPcode{doublefun}
  draw lmt_contour [

```

```

xmin = -3, xmax = 3, xstep = .01,
ymin = -1, ymax = 1, ystep = .01,

levels      = 10,
default    = .5,
height     = 5cm,
function   = "x^2 + y^2 + x + y/2",
color      = "lin(1), 1/2, 0",
background = "band",
foreground = "none",
cache      = true,
] xsize TextWidth ;

```

\stopMPcode

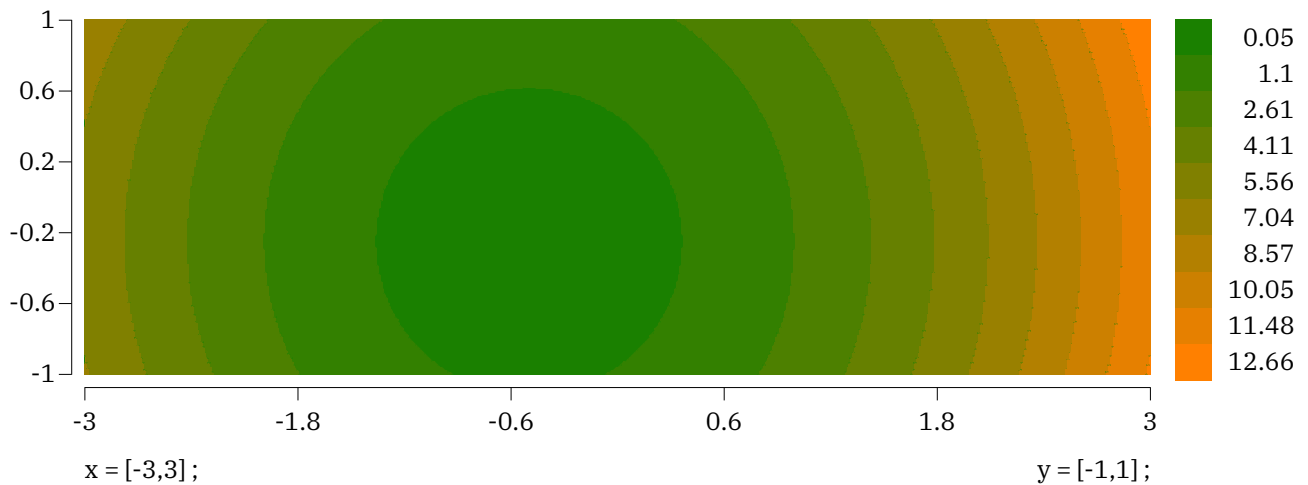

Figure 9.5

You can draw several functions and see where they overlap:

```

\startMPcode{doublefun}
draw lmt_contour [
  xmin = -pi, xmax = 4*pi, xstep = .1,
  ymin = -3, ymax = 3, ystep = .1,

  range      = { -.1, .1 },
  preamble   = "local sin, cos = math.sin, math.cos",
  functions  = {
    "sin(x) + sin(y)", "sin(x) + cos(y)",
    "cos(x) + sin(y)", "cos(x) + cos(y)"
  },
  background = "bitmap",
  linecolor  = "black",
  linewidth  = 1/10,
  color      = "shade({1,1,0},{0,0,1})"
  cache      = true,
] xsize TextWidth ;
\stopMPcode

```

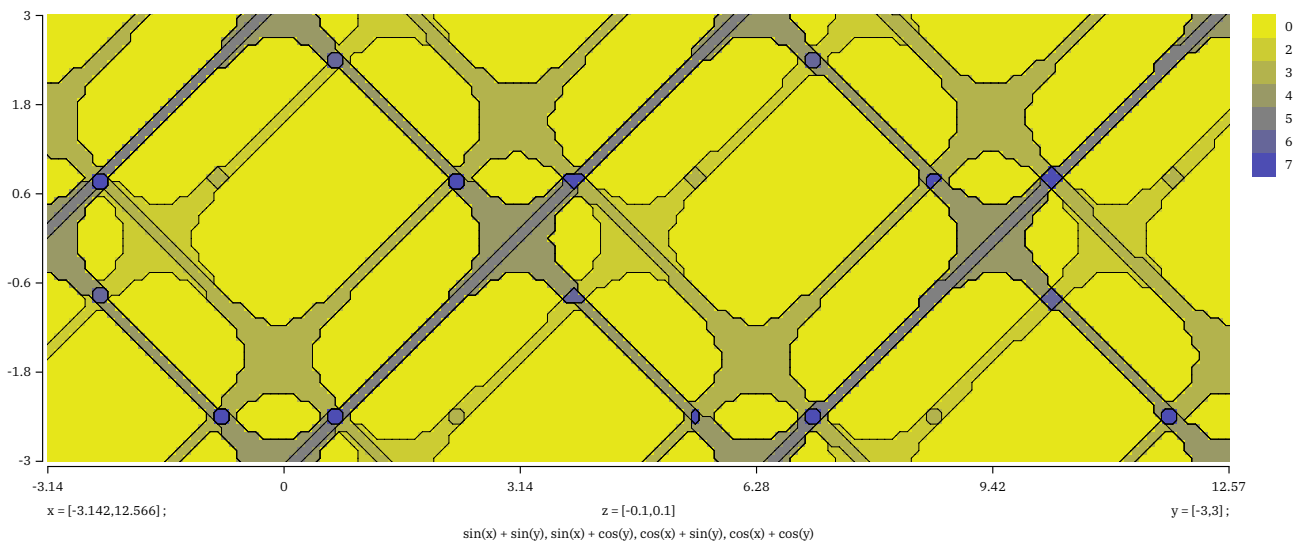

Figure 9.6

The range determines the z value(s) that we take into account. You can also pass a list of colors to be used. In figure 9.7 this is demonstrated. There we also show a variant foreground cell, which uses a bit different method for calculating the edges.³

```
\startMPcode{doublefun}
  draw lmt_contour [
    xmin = -2*pi, xmax = 2*pi, xstep = .01,
    ymin = -3,   ymax = 3,   ystep = .01,

    range      = { -.1, .1 },
    preamble   = "local sin, cos = math.sin, math.cos",
    functions  = { "sin(x) + sin(y)", "sin(x) + cos(y)" },
    background = "bitmap",
    foreground = "cell",
    linecolor  = "white",
    linewidth  = 1/10,
    colors     = { (1/2,1/2,1/2), red, green, blue },
    level      = 3,
    linewidth  = 6,
    cache      = true,
  ] x sized TextWidth ;
\stopMPcode
```

Here the number of levels depends on the number of functions as each can overlap with another; for instance the outcome of two functions can overlap or not which means 3 cases, and with a value not being seen that gives 4 different cases.

```
\startMPcode{doublefun}
  draw lmt_contour [
    xmin = -2*pi, xmax = 2*pi, xstep = .01,
    ymin = -3,   ymax = 3,   ystep = .01,
```

³ This a bit of a playground: more variants might show up in due time.

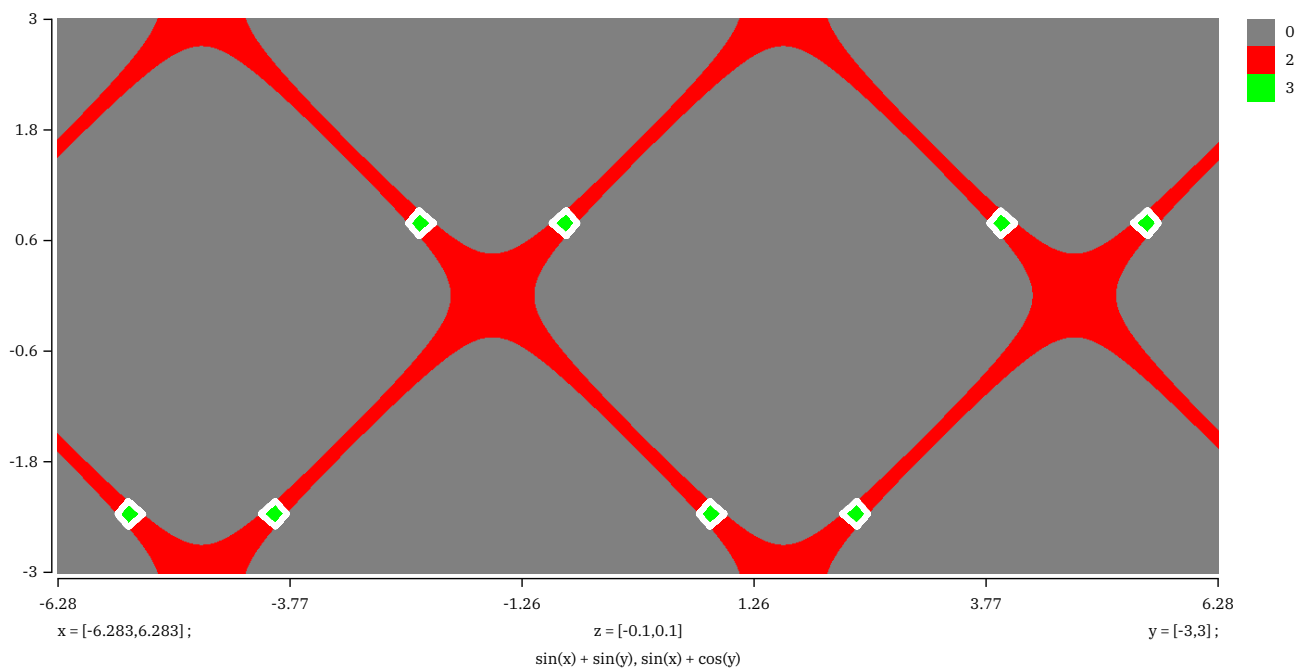

Figure 9.7

```

range      = { -.1, .1 },
preamble   = "local sin, cos = math.sin, math.cos",
functions  = {
    "sin(x) + sin(y)",
    "sin(x) + cos(y)",
    "cos(x) + sin(y)",
    "cos(x) + cos(y)"
},
background = "bitmap",
foreground  = "none",
level      = 3,
color      = "shade({2/3,0,0},{2/3,1,2/3})"
cache      = true,
] xsize TextWidth ;

```

\stopMPcode

Of course one can wonder how useful showing many functions but it can give nice pictures, as shown in figure 9.8.

```

\startMPcode{doublefun}
draw lmt_contour [
    xmin = -2*pi, xmax = 2*pi, xstep = .01,
    ymin = -3,   ymax = 3,   ystep = .01,

    range      = { -.3, .3 },
    preamble   = "local sin, cos = math.sin, math.cos",
    functions  = {
        "sin(x) + sin(y)",
        "sin(x) + cos(y)",
        "cos(x) + sin(y)",
    }
]

```

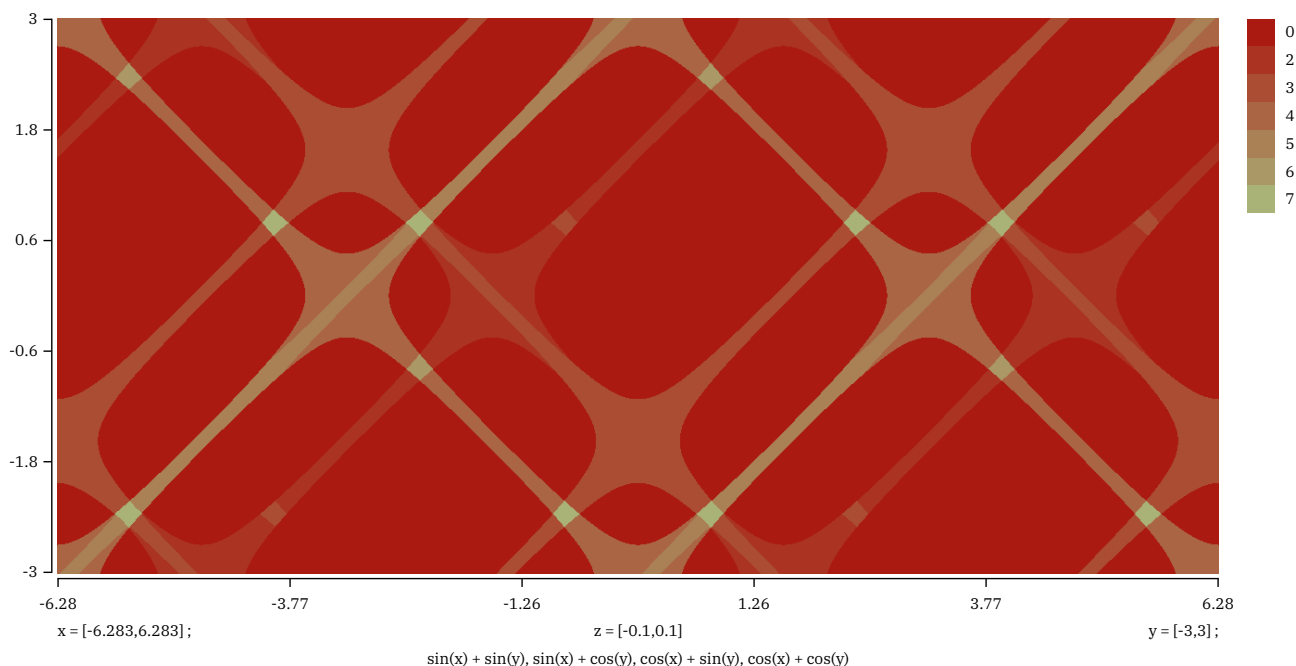

Figure 9.8

```

"cos(x) + cos(y)"
},
background = "bitmap",
foreground = "none",
level      = 3,
color      = "shade({1,0,0},{0,1,0})"
cache      = true,
] x sized TextWidth ;

```

\stopMPcode

We can enlarge the window, which is demonstrated in figure 9.9. I suppose that such images only make sense in educational settings.

In figure 9.10 we see different combinations of backgrounds (in color) and foregrounds (edges) in action.

```

\startMPcode{doublefun}
draw lmt_contour [
  xmin = 0, xmax = 4*pi, xstep = 0,
  ymin = -6, ymax = 6,   ystep = 0,

  levels = 5, legend = false, linewidth = 1/2,

  preamble = "local sin, cos = math.sin, math.cos",
  function  = "cos(x) - sin(y)",
  color     = "shade({1/2,0,0},{0,0,1/2})",

  background = "bitmap", foreground = "cell",
] x sized .3TextWidth ;

```

\stopMPcode

There are quite some settings. Some deal with the background, some with the foreground and quite some deal with the legend.

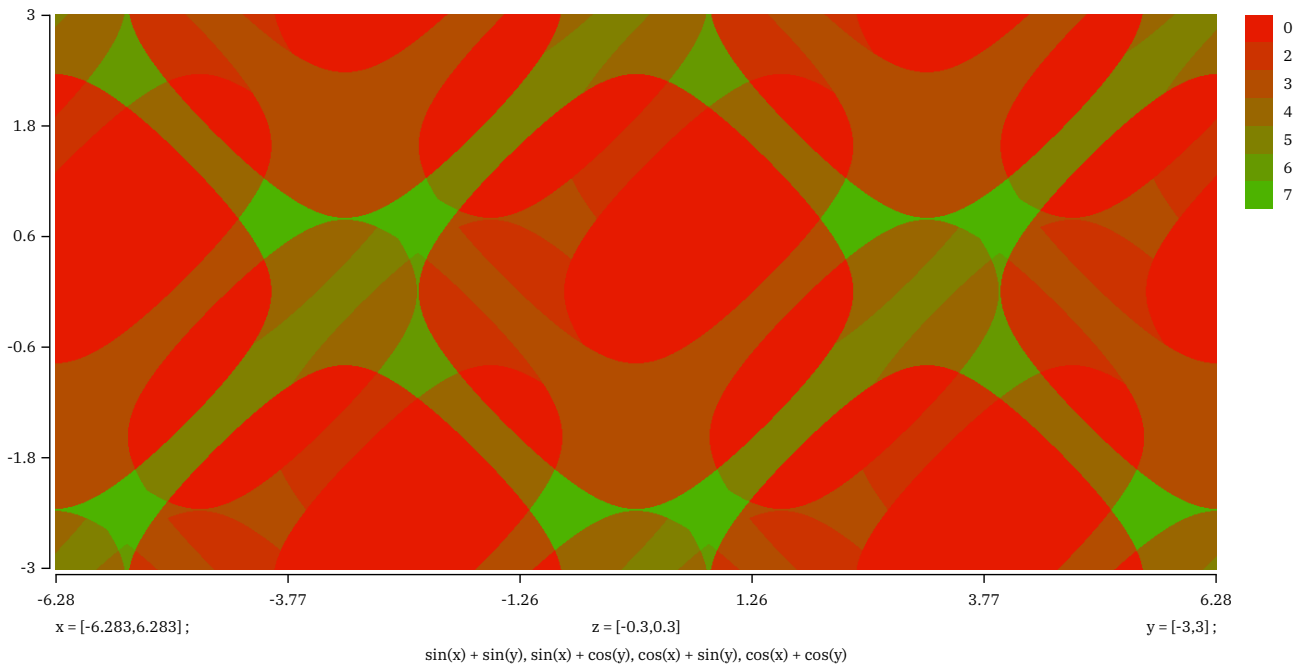
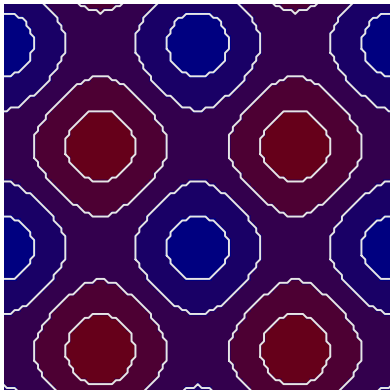

Figure 9.9

name	type	default	comment
xmin	numeric	0	needs to be set
xmax	numeric	0	needs to be set
ymin	numeric	0	needs to be set
ymax	numeric	0	needs to be set
xstep	numeric	0	auto 1/200 when zero
ystep	numeric	0	auto 1/200 when zero
checkresult	boolean	false	checks for overflow and NaN
defaultnan	numeric	0	the value to be used when NaN
defaultinf	numeric	0	the value to be used when overflow
levels	numeric	10	number of different levels to show
level	numeric		only show this level (foreground)
preamble	string		shortcuts
function	string	x + y	the result z value
functions	list		multiple functions (overlapping levels)
color	string	lin(1)	the result color value for level l (1 or 3 values)
colors	numeric		used when set
background	string	bitmap	band, bitmap, shape
foreground	string	auto	cell, edge, shape auto
linewidth	numeric	.25	
linecolor	string	gray	
width	numeric	0	automatic when zero
height	numeric	0	automatic when zero
trace	boolean	false	
legend	string	all	x y z function range all
legendheight	numeric	LineHeight	

legendwidth	numeric	LineHeight	
legendgap	numeric	0	
legendedistance	numeric	EmWidth	
textdistance	numeric	2EmWidth/3	
functiondistance	numeric	ExHeight	
functionstyle	string		ConT _E Xt style name
xformat	string	@0.2N	number format template
yformat	string	@0.2N	number format template
zformat	string	@0.2N	number format template
xstyle	string		ConT _E Xt style name
ystyle	string		ConT _E Xt style name
zstyle	string		ConT _E Xt style name
<hr/>			
axisdistance	numeric	ExHeight	
axislinewidth	numeric	.25	
axisoffset	numeric	ExHeight/4	
axiscolor	string	black	
ticklength	numeric	ExHeight	
<hr/>			
xtick	numeric	5	
ytick	numeric	5	
xlabel	numeric	5	
ylabel	numeric	5	
<hr/>			



bitmap edge

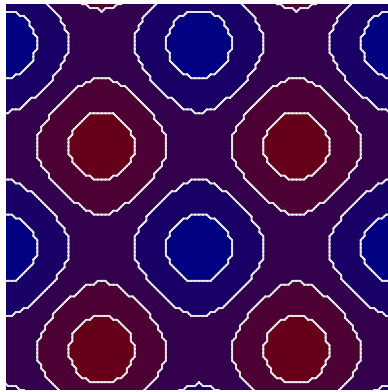

bitmap cell

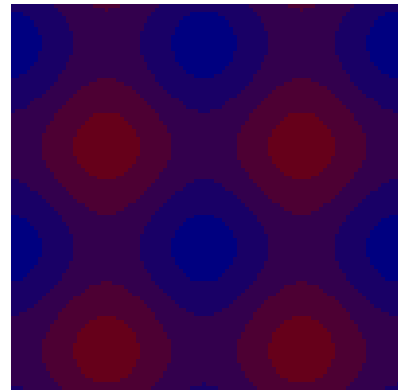

bitmap none

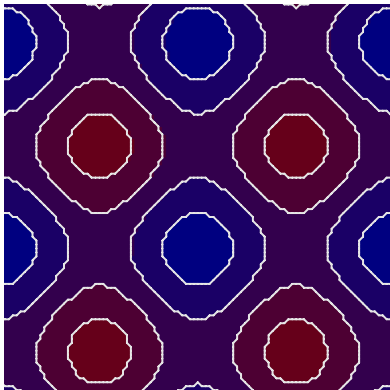

shape shape

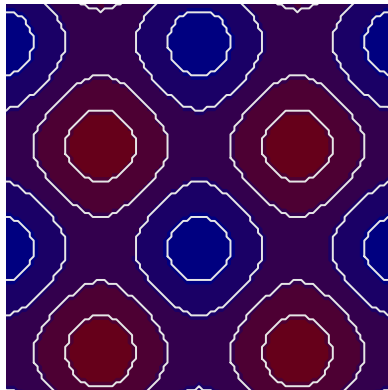

shape edge

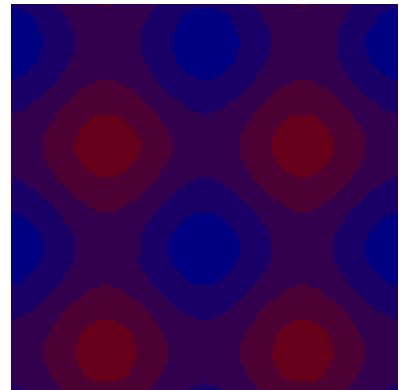

shape none

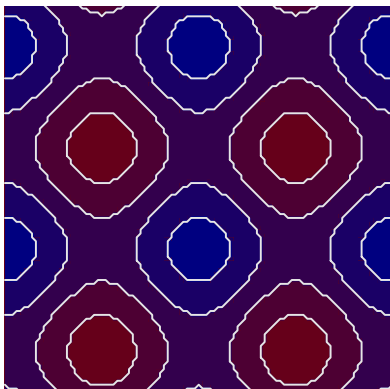

band edge

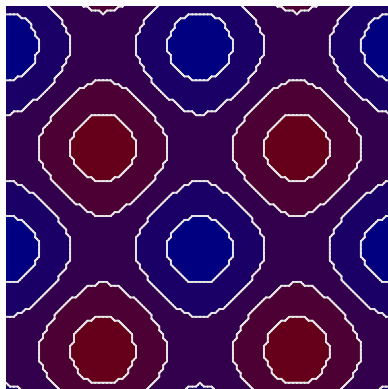

band cell

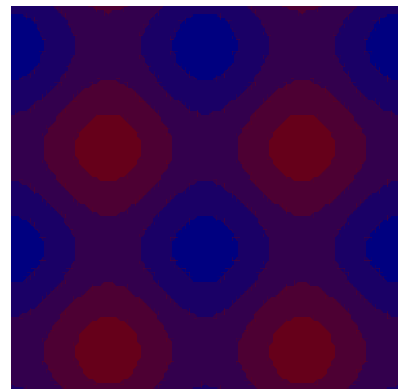

band none

Figure 9.10

10 Surface

This is work in progress so only some examples are shown here. Yet to be decided is how we deal with axis and such.

In figure 10.1 we see an example of a plot with axis as well as lines drawn.

```
\startMPcode{doublefun}  
  draw lmt_surface [  
    preamble = "local sin, cos = math.sin, math.cos",  
    code      = "sin(x*x) - cos(y*y)"  
    xmin      = -3,  
    xmax      = 3,  
    ymin      = -3,  
    ymax      = 3,  
    xvector   = { -0.3, -0.3 },  
    height    = 5cm,  
    axis      = { 40mm, 40mm, 30mm },  
    clipaxis  = true,  
    axiscolor = "gray",  
  ] xsized .8TextWidth ;  
\stopMPcode
```

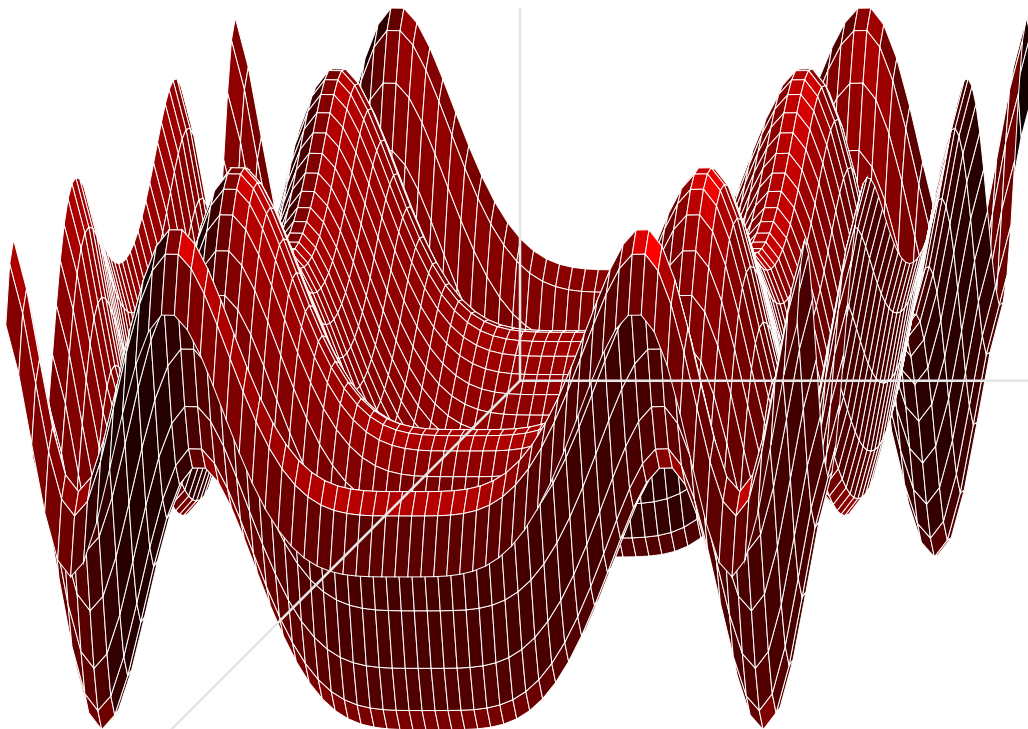

Figure 10.1

In figure 10.2 we don't draw the axis and lines. We also use a high resolution.

```
\startMPcode{doublefun}  
  draw lmt_surface [  
    preamble = "local sin, cos = math.sin, math.cos",  
    code      = "sin(x*x) - cos(y*y)"  
    xmin      = -3,  
    xmax      = 3,  
    ymin      = -3,  
    ymax      = 3,  
    xvector   = { -0.3, -0.3 },  
    height    = 5cm,  
    clipaxis  = true,  
    axiscolor = "gray",  
  ] xsized .8TextWidth ;  
\stopMPcode
```

```

preamble = "local sin, cos = math.sin, math.cos",
code     = "sin(x*x) - cos(y*y)"
color    = "f, f/2, 1-f"
color    = "f, f, 0"
xstep    = .02,
ystep    = .02,
xvector  = { -0.4, -0.4 },
height   = 5cm,
lines    = false,
] x sized .8TextWidth ;
\stopMPcode

```

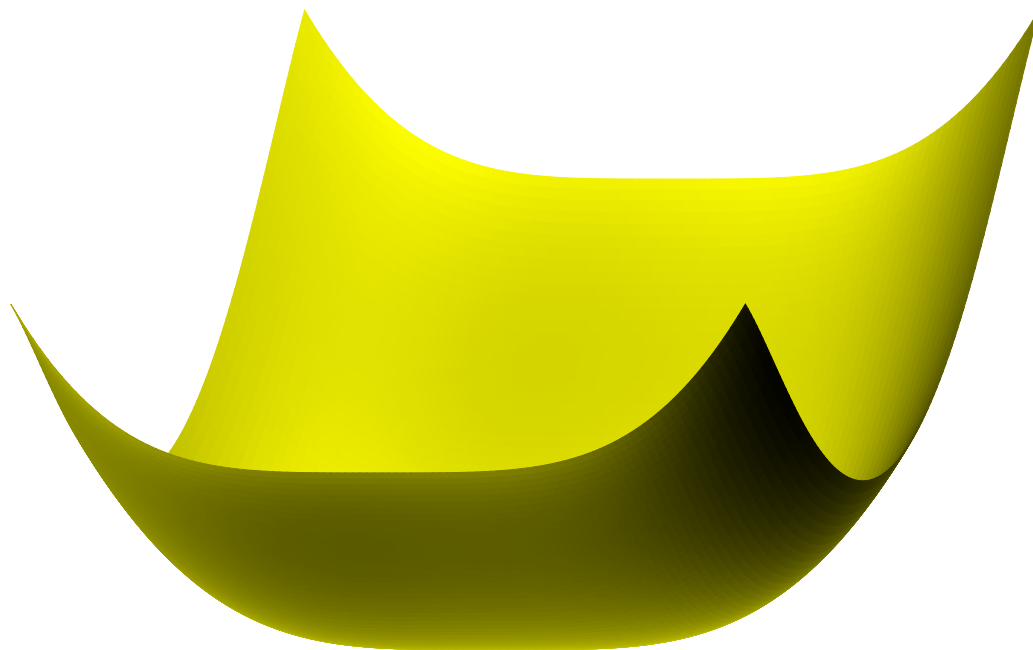

Figure 10.2

The preliminary set of parameters is:

name	type	default	comment
code	string		color string" f, 0, 0"
linecolor	numeric	1	gray scale
xmin	numeric	-1	
xmax	numeric	1	
ymin	numeric	-1	
ymax	numeric	1	
xstep	numeric	.1	
ystep	numeric	.1	
snap	numeric	.01	
xvector	list	{ -0.7, -0.7 }	
yvector	list	{ 1, 0 }	
zvector	list	{ 0, 1 }	
light	list	{ 3, 3, 10 }	
bright	numeric	100	
clip	boolean	false	

```
lines          boolean true
axis           list    { }
clipaxis      boolean false
axiscolor     string  "gray"
axislinewidth numeric 1/2
```

11 Mesh

This is more a gimmick than of real practical use. A mesh is a set of paths that gets transformed into hyperlinks. So, as a start you need to enable these:

`\setupinteraction`

```
[state=start,  
color=white,  
contrastcolor=white]
```

We just give a bunch of examples of meshes. A path is divided in smaller paths and each of them is part of the same hyperlink. An application is for instance clickable maps but (so far) only Acrobat supports such paths.

`\startuseMPgraphic{MyPath1}`

```
fill OverlayBox withcolor "darkyellow" ;  
save p ; path p[] ;  
p1 := unitsquare xysized( OverlayWidth/4, OverlayHeight/4) ;  
p2 := unitsquare xysized(2OverlayWidth/4,3OverlayHeight/5) shifted (  
OverlayWidth/4,0) ;  
p3 := unitsquare xysized( OverlayWidth/4, OverlayHeight ) shifted (3  
OverlayWidth/4,0) ;  
fill p1 withcolor "darkred" ;  
fill p2 withcolor "darkblue" ;  
fill p3 withcolor "darkgreen" ;  
draw lmt_mesh [ paths = { p1, p2, p3 } ] ;  
setbounds currentpicture to OverlayBox ;
```

`\stopuseMPgraphic`

Such a definition is used as follows. First we define the mesh as overlay:

`\defineoverlay[MyPath1][\useMPgraphic{MyPath1}]`

Then, later on, this overlay can be used as background for a button. Here we just jump to another page. The rendering is shown in figure 11.1.

`\button`

```
[height=3cm,  
width=4cm,  
background=MyPath1,  
frame=off]  
{Example 1}  
[realpage(2)]
```

More interesting are non-rectangular shapes so we show a bunch of them. You can pass multiple paths, influence the accuracy by setting the number of steps and show the mesh with the tracing option.

`\startuseMPgraphic{MyPath2}`

```
save q ; path q ; q := unitcircle xysized(OverlayWidth,OverlayHeight) ;  
save p ; path p ; p := for i=1 upto length(q) :
```



Figure 11.1

```

    (center q) -- (point (i-1) of q) -- (point i of q) -- (center q) --
endfor cycle ;
fill q withcolor "darkgray" ;
draw lmt_mesh [
    trace = true,
    paths = { p }
] withcolor "darkred" ;

setbounds currentpicture to OverlayBox ;
\stopuseMPgraphic

\startuseMPgraphic{MyPath3}
save q ; path q ; q := unitcircle xysized(OverlayWidth,OverlayHeight)
    randomized 3mm ;
fill q withcolor "darkgray" ;
draw lmt_mesh [
    trace = true,
    paths = { meshed(q,OverlayBox,.05) }
] withcolor "darkgreen" ;
% draw OverlayMesh(q,.025) withcolor "darkgreen" ;
setbounds currentpicture to OverlayBox ;
\stopuseMPgraphic

\startuseMPgraphic{MyPath4}
save q ; path q ; q := unitcircle xysized(OverlayWidth,OverlayHeight)
    randomized 3mm ;
fill q withcolor "darkgray" ;
draw lmt_mesh [
    trace = true,
    auto = true,
    step = 0.0125,
    paths = { q }
] withcolor "darkyellow" ;
setbounds currentpicture to OverlayBox ;
\stopuseMPgraphic

\startuseMPgraphic{MyPath5}
save q ; path q ; q := unitdiamond xysized(OverlayWidth,OverlayHeight)
    randomized 2mm ;
q := q shifted - center q shifted center OverlayBox ;
fill q withcolor "darkgray" ;
draw lmt_mesh [

```

```

        trace = true,
        auto   = true,
        step   = 0.0125,
        paths  = { q }
    ] withcolor "darkmagenta" ;
    setbounds currentpicture to OverlayBox ;
\stopuseMPgraphic

\startuseMPgraphic{MyPath6}
    save p ; path p[] ;
    p1 := p2 := fullcircle xysized(2OverlayWidth/5,2OverlayHeight/3) ;
    p1 := p1 shifted - center p1 shifted center OverlayBox shifted (-1
        OverlayWidth/4,0) ;
    p2 := p2 shifted - center p2 shifted center OverlayBox shifted ( 1
        OverlayWidth/4,0) ;
    fill p1 withcolor "middlegray" ;
    fill p2 withcolor "middlegray" ;
    draw lmt_mesh [
        trace = true,
        auto   = true,
        step   = 0.02,
        paths  = { p1, p2 }
    ] withcolor "darkcyan" ;
    setbounds currentpicture to OverlayBox ;
\stopuseMPgraphic

\startuseMPgraphic{MyPath7}
    save p ; path p[] ;
    p1 := p2 := fullcircle xysized(2OverlayWidth/5,2OverlayHeight/3) rotated 45
        ;
    p1 := p1 shifted - center p1 shifted center OverlayBox shifted (-1
        OverlayWidth/4,0) ;
    p2 := p2 shifted - center p2 shifted center OverlayBox shifted ( 1
        OverlayWidth/4,0) ;
    fill p1 withcolor "middlegray" ;
    fill p2 withcolor "middlegray" ;
    draw lmt_mesh [
        trace = true,
        auto   = true,
        step   = 0.01,
        box    = OverlayBox enlarged -5mm,
        paths  = { p1, p2 }
    ] withcolor "darkcyan" ;
    draw OverlayBox enlarged -5mm withcolor "darkgray" ;
    setbounds currentpicture to OverlayBox ;
\stopuseMPgraphic

```

This is typical a feature that, if used at all, needs some experimenting but at least the traced images look interesting enough. The six examples are shown in figure 11.2.

MyPath3

MyPath5

MyPath7

Figure 11.2

12 Function

It is tempting to make helpers that can do a lot. However, that also means that we need to explain a lot. Instead it makes more sense to have specific helpers and just make another one when needed. Rendering functions falls into this category. At some point users will come up with specific cases that other users can use. Therefore, the solution presented here is not the ultimate answer. We start with a simple example:

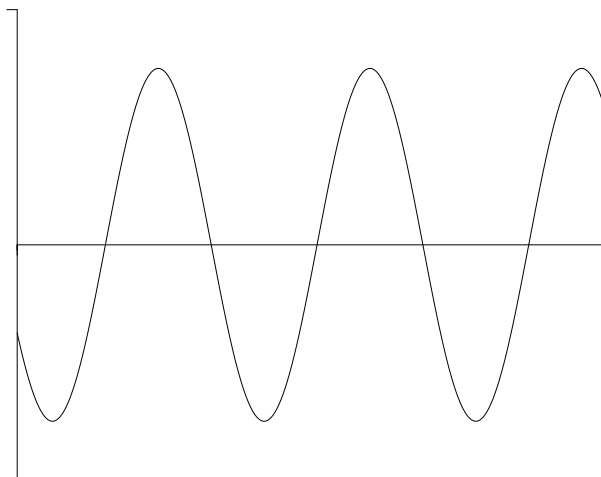

Figure 12.1

This image is defined as follows:

```
\startMPcode{doublefun}
  draw lmt_function [
    xmin = 0, xmax = 20, xstep = .1,
    ymin = -2, ymax = 2,

    sx = 1mm, xsmall = 80, xlarge = 20,
    sy = 4mm, ysmall = 40, ylarge = 4,

    linewidth = .025mm, offset = .1mm,

    code = "1.5 * math.sind (50 * x - 150)",
  ]
  x sized 8cm
;
\stopMPcode
```

We can draw multiple functions in one go. The next sample split the drawing over a few ranges and is defined as follows; in figure 12.2 we see the result.

```
\startMPcode{doublefun}
  draw lmt_function [
    xmin = 0, xmax = 20, xstep = .1,
    ymin = -2, ymax = 2,

    sx = 1mm, xsmall = 80, xlarge = 20,
    sy = 4mm, ysmall = 40, ylarge = 4,
```

```

linewidth = .025mm, offset = .1mm,

xticks    = "bottom",
yticks    = "left",
xlabel    = "nolimits",
ylabel    = "yes",
code      = "1.5 * math.sind (50 * x - 150)",
% frame   = "ticks",
frame     = "sticks",
ycaption  = "\strut \rotate[rotation=90]{something vertical, using
             $\sin{x}$}",
xcaption  = "\strut something horizontal",
functions = {
    [ xmin = 1.0, xmax = 7.0, close = true, fillcolor = "darkred" ],
    [ xmin = 7.0, xmax = 12.0, close = true, fillcolor = "darkgreen" ],
    [ xmin = 12.0, xmax = 19.0, close = true, fillcolor = "darkblue" ],
    [
        drawcolor = "darkyellow",
        drawsize   = 2
    ]
}
]
xsize TextWidth
;
\stopMPcode

```

Instead of the same function, we can draw different ones and when we use transparency we get nice results too.

```

\definecolor[MyColorR][r=.5,t=.5,a=1]
\definecolor[MyColorG][g=.5,t=.5,a=1]
\definecolor[MyColorB][b=.5,t=.5,a=1]

\startMPcode{doublefun}
draw lmt_function [
    xmin = 0, xmax = 20, xstep = .1,
    ymin = -1, ymax = 1,

    sx = 1mm, xsmall = 80, xlarge = 20,
    sy = 4mm, ysmall = 40, ylarge = 4,

    linewidth = .025mm, offset = .1mm,

    functions = {
        [
            code      = "math.sind (50 * x - 150)",
            close     = true,
            fillcolor = "MyColorR"
        ],
        [
            code      = "math.cosd (50 * x - 150)",

```

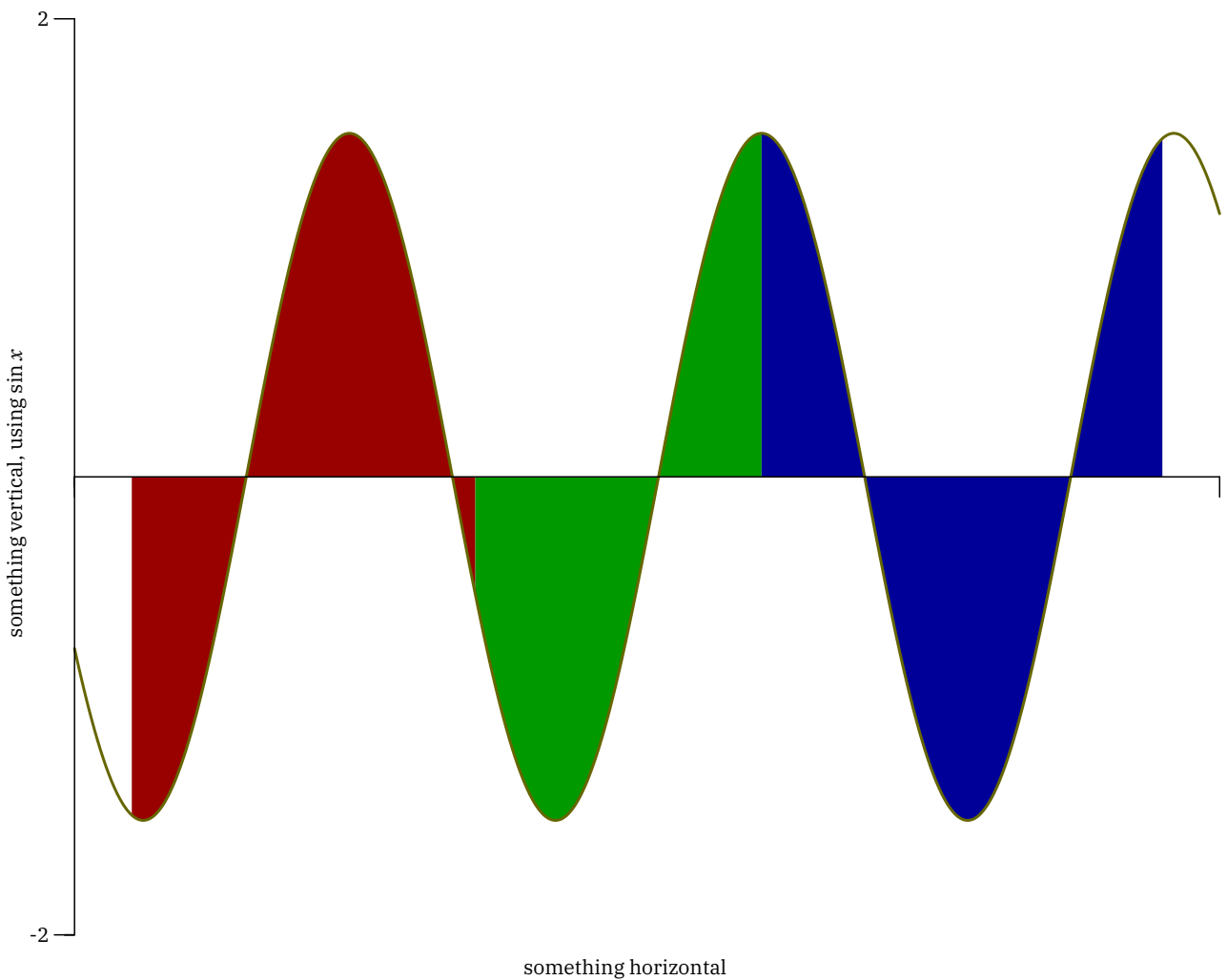

Figure 12.2

```

        close      = true,
        fillcolor = "MyColorB"
    ],
    },
]
xsize TextWidth
;

```

\stopMPcode

It is important to choose a good step. In figure 12.4 we show 4 variants and it is clear that in this case using straight line segments is better (or at least more efficient with small steps).

```

\startMPcode{doublefun}
draw lmt_function [
  xmin = 0, xmax = 10, xstep = .1,
  ymin = -1, ymax = 1,

  sx = 1mm, sy = 4mm,

  linewidth = .025mm, offset = .1mm,

```

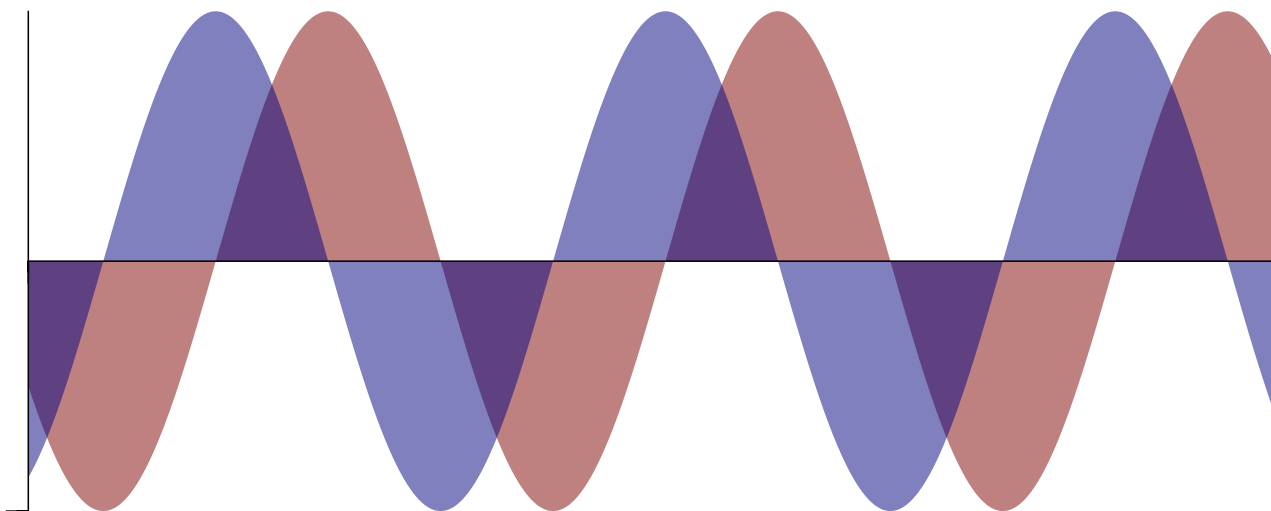

Figure 12.3

```
code = "math.sind (50 * x^2 - 150)",
shape = "curve"
]
xsize .45TextWidth
;
```

\stopMPcode

You can manipulate the axis (a bit) by tweaking the first and last ticks. In the case of figure 12.5 we also put the shape on top of the axis.

```
\startMPcode{doublefun}
draw lmt_function [
xfirst = 9, xlast = 21, ylarge = 2, ysmall = 1/5,
yfirst = -1, ylast = 1, xlarge = 2, xsmall = 1/4,

xmin = 10, xmax = 20, xstep = .25,
ymin = -1, ymax = 1,

drawcolor = "darkmagenta",
shape = "steps",
code = "0.5 * math.random(-2,2)",
linewidth = .025mm,
offset = .1mm,
reverse = true,
]
xsize TextWidth
;
```

\stopMPcode

The whole repertoire of parameters (in case of doubt just check the source code as this kind of code is not that hard to follow) is:

name	type	default	comment
sx	numeric	1mm	horizontal scale factor

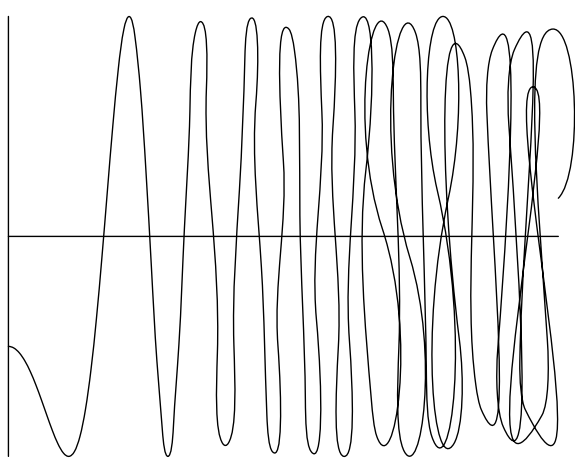

xstep=.10 and shape="curve"

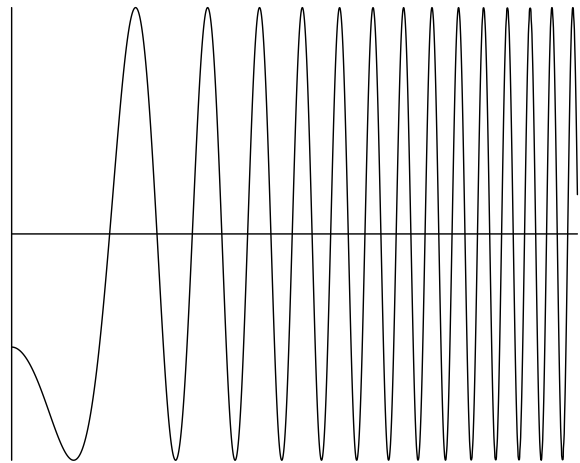

xstep=.01 and shape="curve"

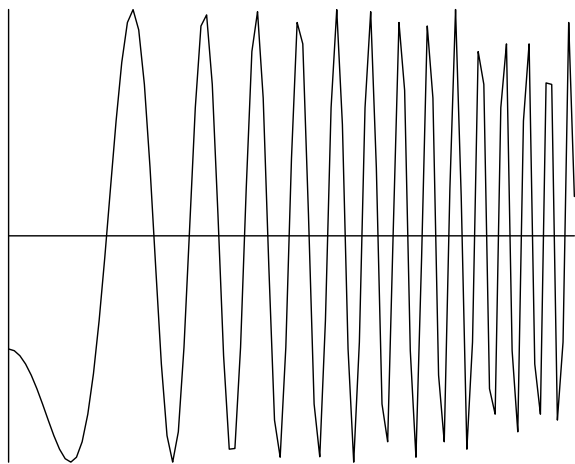

xstep=.10 and shape="line"

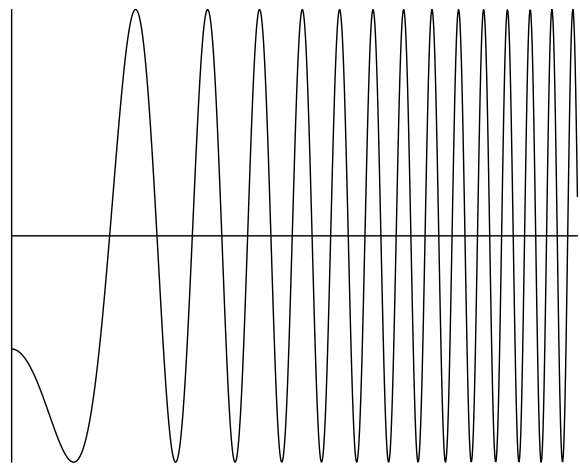

xstep=.01 and shape="line"

Figure 12.4

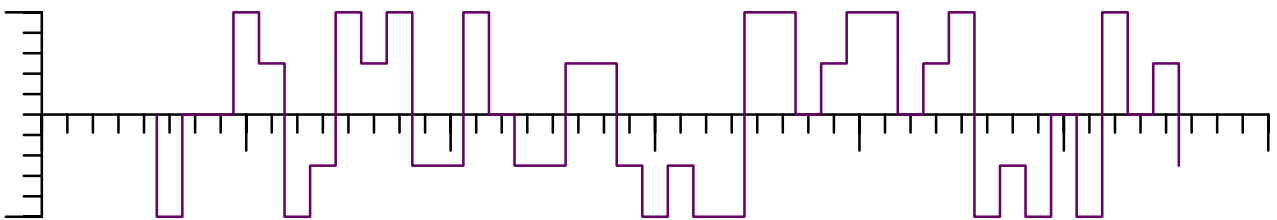

Figure 12.5

sy	numeric	1mm	vertical scale factor
offset	numeric	0	
xmin	numeric	1	
xmax	numeric	1	
xstep	numeric	1	
xsmall	numeric		optional step of small ticks
xlarge	numeric		optional step of large ticks
xlabel	string	no	yes, no or nolimits
xticks	string	bottom	possible locations are top, middle and bottom
xcaption	string		
ymin	numeric	1	

ymax	numeric	1	
ystep	numeric	1	
ysmall	numeric		optional step of small ticks
ylarge	numeric		optional step of large ticks
xfirst	numeric		left of xmin
xlast	numeric		right of xmax
yfirst	numeric		below ymin
ylast	numeric		above ymax
ylabels	string	no	yes, no or nolimits
yticks	string	left	possible locations are left, middle and right
ycaption	string		
code	string		
close	boolean	false	
shape	string	curve	or line
fillcolor	string		
drawsize	numeric	1	
drawcolor	string		
frame	string		options are yes, ticks and sticks
linewidth	numeric	.05mm	
pointsymbol	string		like type dots
pointsize	numeric	2	
pointcolor	string		
xarrow	string		
yarrow	string		
reverse	boolean	false	when true draw the function between axis and labels

In the beginning of 2025 we added support for sampled functions and parametric plots. Here are some examples but keep in mind that the interfaces might be extended.

\startMPcode

```

path p ; p := lmt_samplefunction [
  preamble = "local tan = math.tan",
  code      = "return tan(x)",
  xmin      = -5*pi,
  xmax      = 5*pi,
  ymin      = -10,
  ymax      = 10,
  % shape   = "curve",
  % tight    = true,
  % tolerance = 0.001,
] scaled 10 ;

draw p withpen pencircle scaled 10 withcolor "darkred" ;
drawdot p withpen pencircle scaled 2.5 withcolor white ;
\stopMPcode

```

We draw with a thick line and show the points that make up the paths. As you can see in figure 12.6 the density is larger where more points are needed. By default the lines are straight (--) but you can use the shape parameter to generate a curve (. .). Keep in mind that not all results come out well when curved,

just test code = "return math.sin(1/x)". In that case, if you think it will be seen, you can decrease the tolerance, say to 0.00005 at the cost for more points.

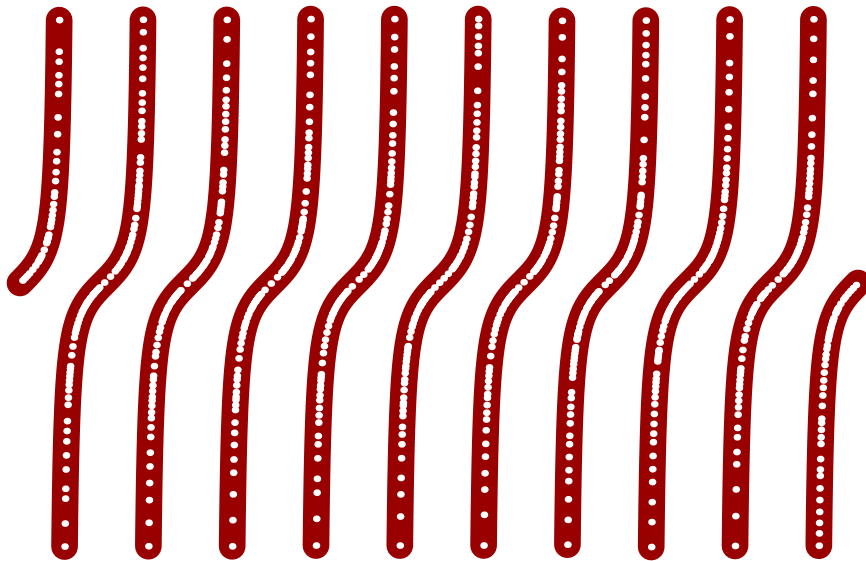

Figure 12.6

A parametric plot runs over a range and gets two or one function passed:

```
\startMPcode
path p ; p := lmt_parametricplot [
  preamble = "local sin, cos = math.sin, math.cos",
  xcode    = "2*cos(t/3)*cos(t)",
  ycode    = "2*cos(t/3)*sin(t)",
  tmin     = 0,
  tmax     = 4*pi,
  tolerance = 0.001,
] ysize 5cm ;

draw p withpen pencircle scaled 10 withcolor "darkred" ;
drawdot p withpen pencircle scaled 2.5 withcolor white ;
\stopMPcode
```

and

```
\startMPcode
path p ; p := lmt_parametricplot [
  preamble = "local sin, cos = math.sin, math.cos",
  rcode    = "1 + cos(t)",
  tmin     = 0,
  tmax     = 2*pi,
  tolerance = 0.00025,
] ysize 5cm ;

draw p withpen pencircle scaled 10 withcolor "darkred" ;
drawdot p withpen pencircle scaled 2.5 withcolor white ;
\stopMPcode
```

show this. The results are collected in figure ?? where again we also highlight the points that make the curve. Drawing these function is of course up to MetaPost but the calculations happen at the Lua end.

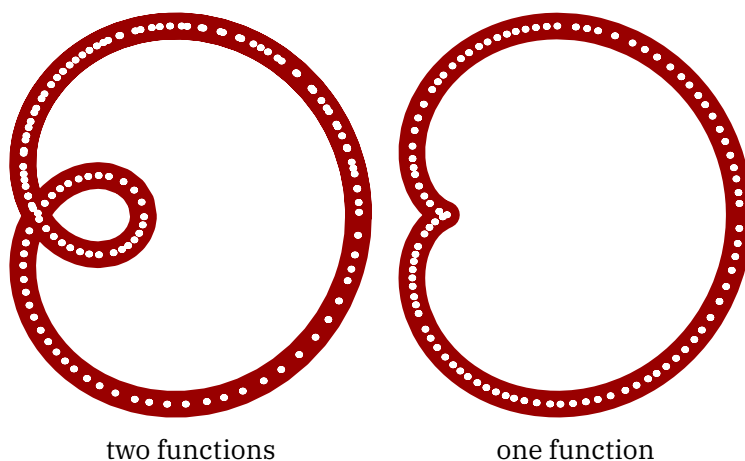

Figure 12.7

Figure 12.8 shows a bit more decorated example, taken from Mikael's lecture notes. The rightmost variant shows the density of the points.

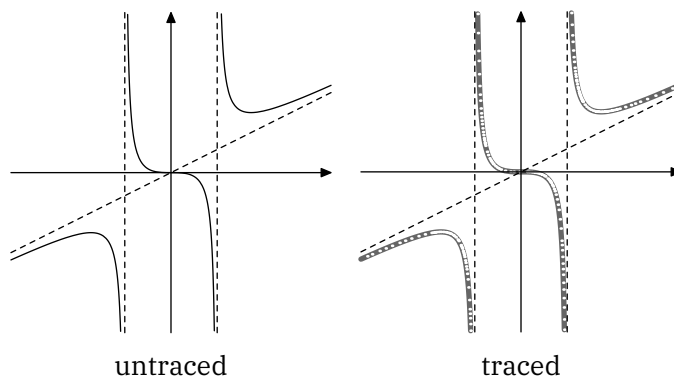

Figure 12.8

```
% usage: \useMPgraphic{sample}{trace=0}

\startuseMPgraphic{sample}{trace}
path p ; p := lmt_samplefunction [
  code = "return x*x*x/(2*x*x - 6)", % no preamble needed
  xmin = -6,
  xmax = 6,
  ymin = -6,
  ymax = 6,
] scaled 10 ;

if \MPvar{trace} == 1 :
  draw p withpen pencircle scaled 2 withcolor .4white ;
  drawdot p withpen pencircle scaled 1 withcolor white ;
else :
  draw p ;
fi ;
```

```
drawarrow (-60, 0) -- (60, 0) ;
drawarrow ( 0,-60) -- ( 0,60) ;
draw (( sqrt(3)*10,-60) -- ( sqrt(3)*10,60)) withdashes 2 ;
draw ((-sqrt(3)*10,-60) -- (-sqrt(3)*10,60)) withdashes 2 ;
draw ((-60,-30) -- (60,30)) withdashes 2 ;
\stopuseMPgraphic
```

13 Chart

This is another example implementation but it might be handy for simple cases of presenting results. Of course one can debate the usefulness of certain ways of presenting but here we avoid that discussion. Let's start with a simple pie chart (figure 13.1).

```
\startMPcode
  draw lmt_chart_circle [
    samples      = { { 1, 4, 3, 2, 5, 7, 6 } },
    percentage   = true,
    trace        = true,
  ] ;
\stopMPcode
```

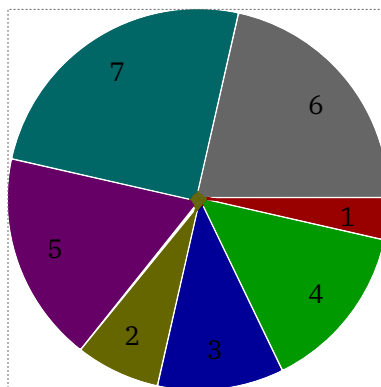

Figure 13.1

As with all these LMTX extensions, you're invited to play with the parameters. in figure 13.2 we see a variant that adds labels as well as one that has a legend.

The styling of labels and legends can be influenced independently.

```
\startMPcode
draw lmt_chart_circle [
  height      = 4cm,
  samples     = { { 1, 4, 3, 2, 5, 7, 6 } },
  percentage  = true,
  trace       = true,
  labelcolor  = "white",
  labelformat = "@0.1f",
  labelstyle  = "ttxx"
] ;
\stopMPcode
```

```
\startMPcode
draw lmt_chart_circle [
  height      = 4cm,
  samples     = { { 1, 4, 3, 2, 5, 7, 6 } },
  percentage  = false,
  trace       = true,

```

```

linewidth = .125mm,
originsize = 0,
labeloffset = 3cm,
labelstyle = "bfxx",
legendstyle = "tfxx",
legend = {
    "first", "second", "third", "fourth",
    "fifth", "sixths", "sevenths"
}
] ;
\stopMPcode

```

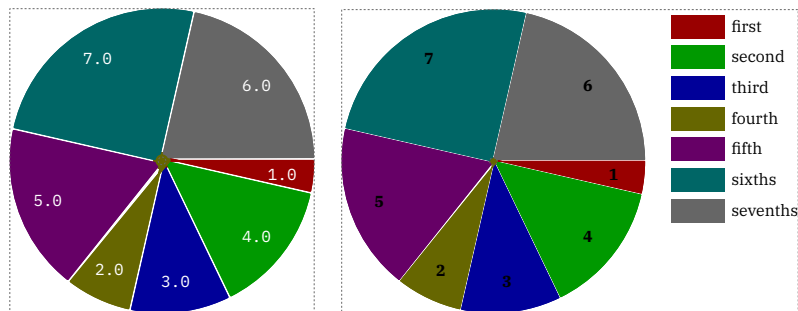

Figure 13.2

A second way of rendering are histograms, and the interface is mostly the same. In figure 13.3 we see two variants

```

\startMPcode
draw lmt_chart_histogram [
    samples = { { 1, 4, 3, 2, 5, 7, 6 } },
    percentage = true,
    cumulative = true,
    trace = true,
] ;
\stopMPcode

```

and one with two datasets:

```

\startMPcode
draw lmt_chart_histogram [
    samples = {
        { 1, 4, 3, 2, 5, 7, 6 },
        { 1, 2, 3, 4, 5, 6, 7 }
    },
    background = "lightgray",
    trace = true,
] ;
\stopMPcode

```

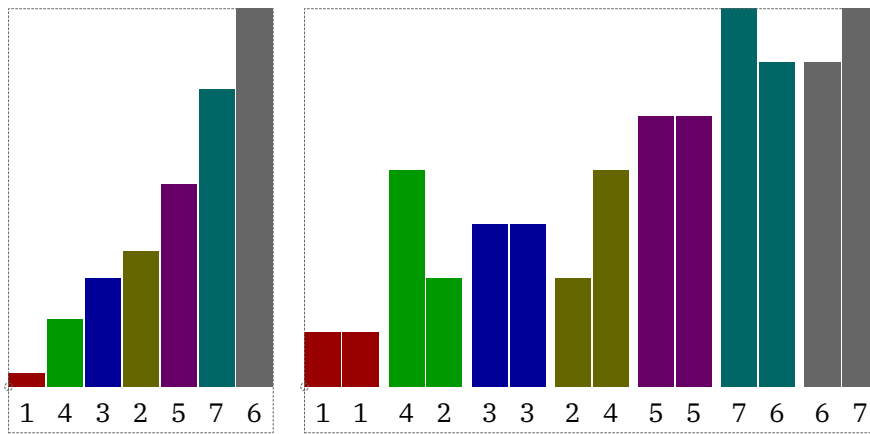

Figure 13.3

A cumulative variant is shown in figure 13.4 where we also add a background (color).

```

\startMPpage[offset=5mm]
  draw lmt_chart_histogram [
    samples      = {
      { 1, 4, 3, 2, 5, 7, 6 },
      { 1, 2, 3, 4, 5, 6, 7 }
    },
    percentage   = true,
    cumulative   = true,
    showlabels   = false,
    backgroundcolor = "lightgray",
  ] ;
\stopMPpage

```

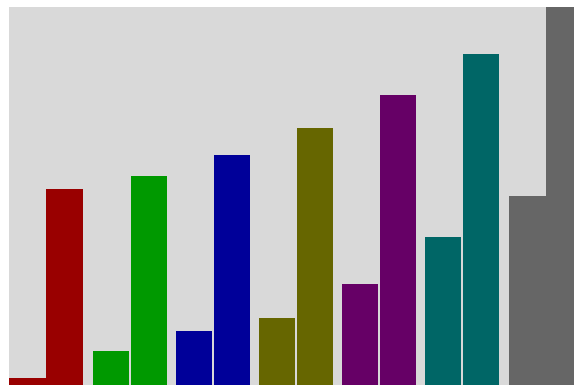

Figure 13.4

A different way of using colors is shown in figure 13.5 where each sample gets its own (same) color.

```

\startMPcode
  draw lmt_chart_histogram [
    samples      = {
      { 1, 4, 3, 2, 5, 7, 6 },
      { 1, 2, 3, 4, 5, 6, 7 }
    }
  ] ;
\stopMPcode

```

```

    },
    percentage = true,
    cumulative = true,
    showlabels = false,
    background = "lightgray",
    colormode = "local",
  ] ;
\stopMPcode

```

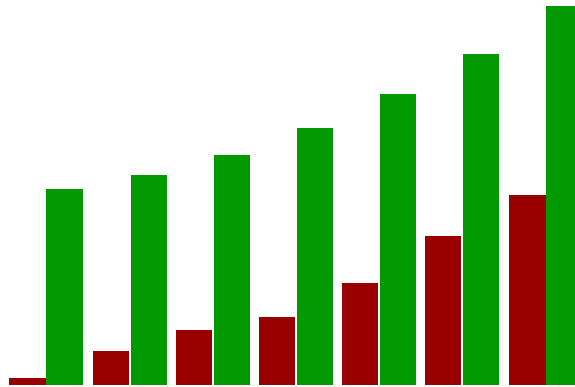

Figure 13.5

As with pie charts you can add labels and a legend:

```

\startMPcode
draw lmt_chart_histogram [
  height      = 6cm,
  samples     = { { 1, 4, 3, 2, 5, 7, 6 } },
  percentage  = true,
  cumulative  = true,
  trace       = true,
  labelstyle  = "ttxx",
  labelanchor = "top",
  labelcolor  = "white",
  backgroundcolor = "middlegray",
] ;
\stopMPcode

```

The previous and next examples are shown in figure 13.6. The height specified here concerns the graphic and excludes the labels,

```

\startMPcode
draw lmt_chart_histogram [
  height      = 6cm,
  width       = 10mm,
  samples     = { { 1, 4, 3, 2, 5, 7, 6 } },
  trace       = true,
  maximum     = 7.5,
  linewidth   = 1mm,
  originsize  = 0,
  labelanchor = "bot",
] ;
\stopMPcode

```

```

labelcolor = "black"
labelstyle = "bfxx"
legendstyle = "tfxx",
labelstrut = "yes",
legend     = {
    "first", "second", "third", "fourth",
    "fifth", "sixths", "sevenths"
}
] ;

```

\stopMPcode

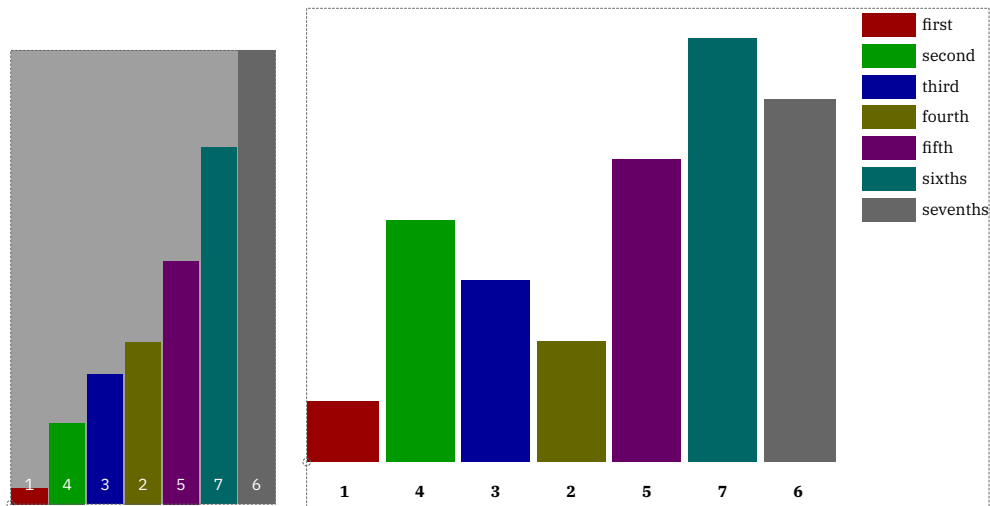

Figure 13.6

The third category concerns bar charts that run horizontal. Again we see similar options driving the rendering (figure 13.7).

\startMPcode

```

draw lmt_chart_bar [
    samples      = { { 1, 4, 3, 2, 5, 7, 6 } },
    percentage   = true,
    cumulative   = true,
    trace        = true,
] ;

```

\stopMPcode

\startMPcode

```

draw lmt_chart_bar [
    samples      = { { 1, 4, 3, 2, 5, 7, 6 } },
    percentage   = true,
    cumulative   = true,
    showlabels   = false,
    backgroundcolor = "lightgray",
] ;

```

\stopMPcode

Determining the offset of labels is manual work:

```

\startMPcode
draw lmt_chart_bar [
  width           = 4cm,
  height          = 5mm,
  samples         = { { 1, 4, 3, 2, 5, 7, 6 } },
  percentage      = true,
  cumulative      = true,
  trace          = true,
  labelcolor      = "white",
  labelstyle      = "ttxx",
  labelanchor     = "rt",
  labeloffset     = .25EmWidth,
  backgroundcolor = "middlegray",
] ;
\stopMPcode

```

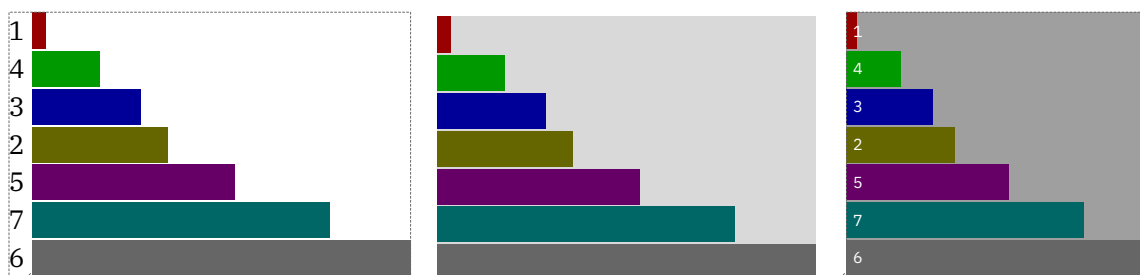

Figure 13.7

Here is one with a legend (rendered in figure 13.8):

```

\startMPcode
draw lmt_chart_bar [
  width           = 8cm,
  height          = 10mm,
  samples         = { { 1, 4, 3, 2, 5, 7, 6 } },
  trace          = true,
  maximum         = 7.5,
  linewidth       = 1mm,
  originsize      = 0,
  labelanchor     = "lft",
  labelcolor      = "black",
  labelstyle      = "bfxx",
  legendstyle     = "tfxx",
  labelstrut      = "yes",
  legend          = {
    "first", "second", "third", "fourth",
    "fifth", "sixths", "sevenths"
  }
] ;
\stopMPcode

```

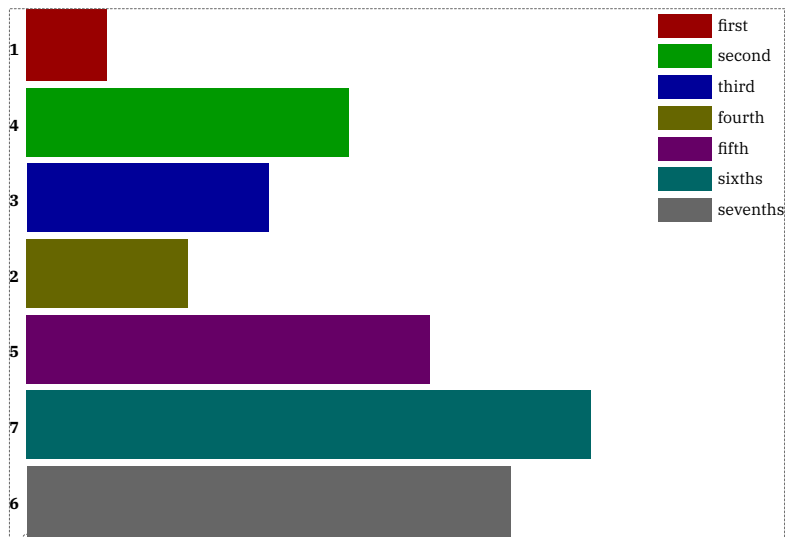

Figure 13.8

You can have labels per dataset as well as draw multiple datasets in one image, see figure 13.9:

\startMPcode

```
draw lmt_chart_bar [
  samples = {
    { 1, 4, 3, 2, 5, 7, 6 },
    { 3, 2, 5, 7, 5, 6, 1 }
  },
  labels = {
    { "a1", "b1", "c1", "d1", "e1", "f1", "g1" },
    { "a2", "b2", "c2", "d2", "e2", "f2", "g2" }
  },
  labeloffset = -EmWidth,
  labelanchor = "center",
  labelstyle = "ttxx",
  trace = true,
  center = true,
] ;
```

```
draw lmt_chart_bar [
  samples = {
    { 1, 4, 3, 2, 5, 7, 6 }
  },
  labels = {
    { "a", "b", "c", "d", "e", "f", "g" }
  },
  labeloffset = -EmWidth,
  labelanchor = "center",
  trace = true,
  center = true,
] shifted (10cm,0) ;
```

\stopMPcode

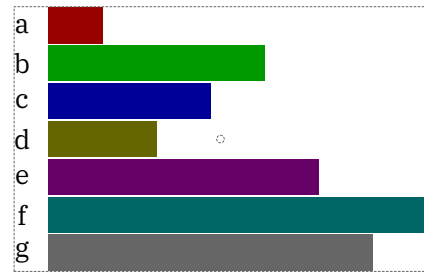
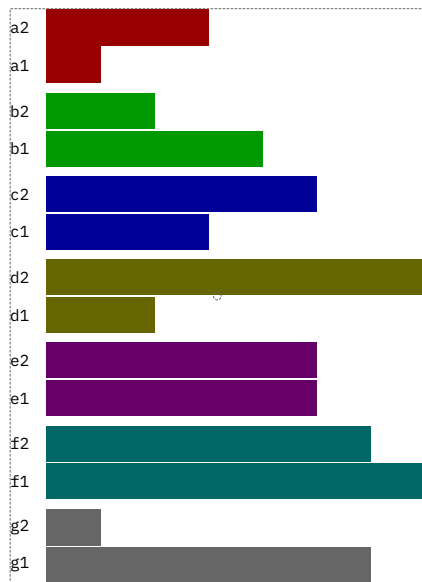

Figure 13.9

name	type	default	comment
originsize	numeric	1mm	
trace	boolean	false	
showlabels	boolean	true	
center	boolean	false	
samples	list		
	cumulative	boolean	false
percentage	boolean	false	
maximum	numeric	0	
distance	numeric	1mm	
labels	list		
labelstyle	string		
labelformat	string		
labelstrut	string	auto	
labelanchor	string		
labeloffset	numeric	0	
labelfraction	numeric	0.8	
labelcolor	string		
backgroundcolor	string		
drawcolor	string	white	
fillcolors	list		primary (dark) colors
colormode	string	global	or local
linewidth	numeric	.25mm	
legendcolor	string		
legendstyle	string		
legend	list		

Pie charts have:

name	default
------	---------

height	5cm
width	5mm
labelanchor	
labeloffset	0
labelstrut	no

Histograms come with:

name	default
height	5cm
width	5mm
labelanchor	bot
labeloffset	1mm
labelstrut	auto

Bar charts use:

name	default
height	5cm
width	5mm
labelanchor	lft
labeloffset	1mm
labelstrut	no

14 SVG

There is not that much to tell about this command. It translates an svg image to MetaPost operators. We took a few images from a mozilla emoji font:

```
\startMPcode
  draw lmt_svg [
    filename = "mozilla-svg-002.svg",
    height   = 2cm,
    width    = 8cm,
  ] ;
\stopMPcode
```

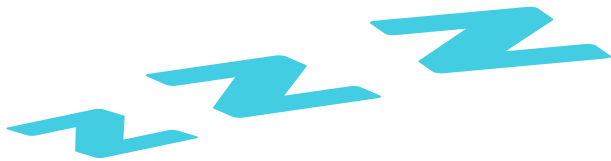

Because we get pictures, you can mess around with them:

```
\startMPcode
  picture p ; p := lmt_svg [ filename = "mozilla-svg-001.svg" ] ;
  numeric w ; w := bbwidth(p) ;
  draw p ;
  draw p xscaled -1 shifted (2.5*w,0) ;
  draw p rotatedaround(center p,45) shifted (3.0*w,0) ;
  draw image (
    for i within p : if filled i :
      draw pathpart i withcolor green ;
    fi endfor ;
  ) shifted (4.5*w,0) ;
  draw image (
    for i within p : if filled i :
      fill pathpart i withcolor red withtransparency (1,.25) ;
    fi endfor ;
  ) shifted (6*w,0) ;
\stopMPcode
```



Of course, often you won't know in advance what is inside the image and how (well) it has been defined so the previous example is more about showing some MetaPost muscle.

The supported parameters are:

name	type	default	comment
filename	path		
width	numeric		
height	numeric		

15 Poisson

When, after a post on the ConT_EXt mailing list, Aditya pointed me to an article on mazes I ended up at poisson distributions which to me looks nicer than what I normally do, fill a grid and then randomize the resulting positions. With some hooks this can be used for interesting patterns too. The algorithm is based on the discussion at:

<http://devmag.org.za/2009/05/03/poisson-disk-sampling>

Other websites mention some variants on that but I saw no reason to look into those in detail. I can imagine more random related variants in this domain so consider this an appetizer. The user is rather simple because some macro is assumed to deal with the rendering of the distributed points. We just show some examples (because the interface might evolve).

```
\startMPcode
  draw lmt_poisson [
    width      = 40,
    height     = 40,
    distance   = 1,
    count      = 20,
    macro      = "draw"
  ] xsize 4cm ;
\stopMPcode
```

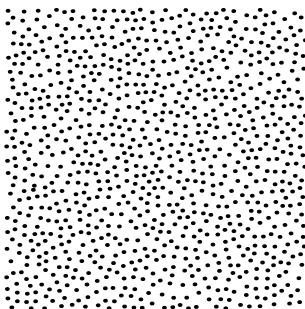

```
\startMPcode
  vardef tst (expr x, y, i, n) =
    fill fullcircle scaled (10+10*(i/n)) shifted (10x,10y)
      withcolor "darkblue" withtransparency (1,.5) ;
  enddef ;

  draw lmt_poisson [
    width      = 50,
    height     = 50,
    distance   = 1,
    count      = 20,
    macro      = "tst",
    arguments  = 4
  ] xsize 6cm ;
\stopMPcode
```

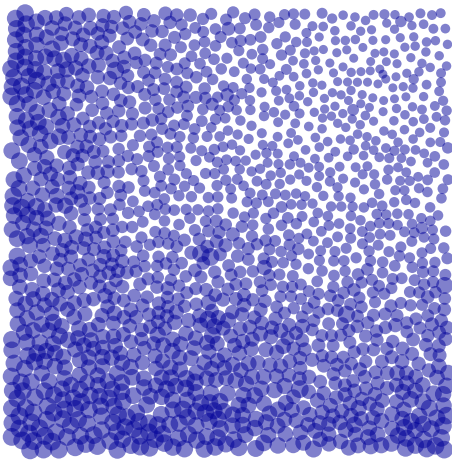

```

\startMPcode
  vardef tst (expr x, y, i, n) =
    fill fulldiamond scaled (5+5*(i/n)) randomized 2 shifted (10x,10y)
      withcolor "darkgreen" ;
  enddef ;

  draw lmt_poisson [
    width      = 50,
    height     = 50,
    distance   = 1,
    count      = 20,
    macro      = "tst",
    initialx   = 10,
    initialy   = 10,
    arguments  = 4
  ] xsize 6cm ;
\stopMPcode

```

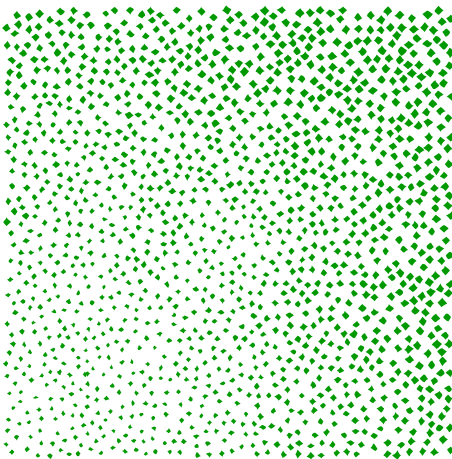

```

\startMPcode{doublefun}
  vardef tst (expr x, y, i, n) =
    fill fulldiamond randomized (.2*i/n) shifted (x,y);
  enddef ;

  draw lmt_poisson [

```

```

width      = 150,
height     = 150,
distance   = 1,
count      = 20,
macro      = "tst",
arguments  = 4
] xsize 6cm withcolor "darkmagenta" ;
\stopMPcode

```

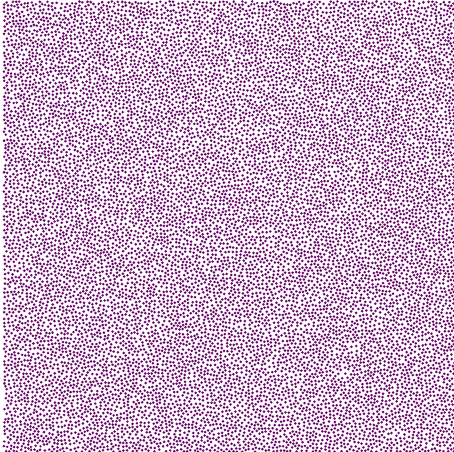

```

\startMPcode
vardef tst (expr x, y, i, n) =
  draw externalfigure "cow.pdf" ysize (10+5*i/n) shifted (10x,10y);
enddef ;
draw lmt_poisson [
width      = 20,
height     = 20,
distance   = 1,
count      = 20,
macro      = "tst"
arguments  = 4,
] xsize 6cm ;
\stopMPcode

```

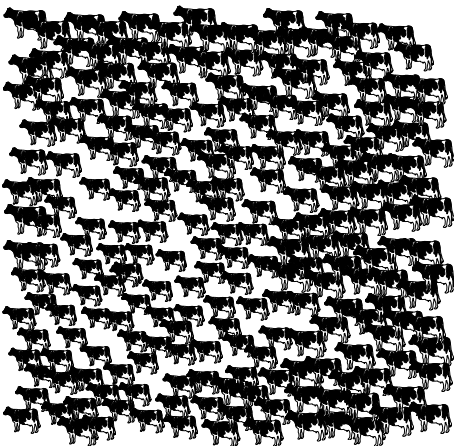

The supported parameters are:

name	type	default	comment
width	numeric	50	
height	numeric	50	
distance	numeric	1	
count	numeric	20	
macro	string	"draw"	
initialx	numeric	10	
initialy	numeric	10	
arguments	numeric	4	

16 Fonts

Fonts are interesting phenomena but can also be quite hairy. Shapes can be missing or not to your liking. There can be bugs too. Control over fonts has always been on the agenda of \TeX macro packages, and Con \TeX t provides a lot of control, especially in MkIV. In LMTX we add some more to that: we bring back MetaFont's but now in the MetaPost way. A simple example shows how this is (maybe I should say: will be) done.

We define three simple shapes and do that (for now) in the `simplefun` instance because that's what is used when generating the glyphs.

```
\startMPcalculation{simplefun}
  vardef TestGlyphLB =
    image (
      fill (unitsquare xscaled 10 yscaled 16 shifted (0,-3))
        withcolor "darkred" withtransparency (1,.5)
    )
  enddef ;

  vardef TestGlyphRB =
    image (
      fill (unitcircle xscaled 15 yscaled 12 shifted (0,-2))
        withcolor "darkblue" withtransparency (1,.5)
    )
  enddef ;

  vardef TestGlyphFS =
    image (
      fill (unittriangle xscaled 15 yscaled 12 shifted (0,-2))
        withcolor "darkgreen" withtransparency (1,.5)
    )
  enddef ;
\stopMPcalculation
```

This is not that spectacular, not is the following:

```
\startMPcalculation{simplefun}
  lmt_registerglyphs [
    name = "test",
    units = 10, % 1000
  ] ;

  lmt_registerglyph [
    category = "test",
    unicode = 123,
    code = "draw TestGlyphLB ;",
```

```

width    = 10, % 1000
height   = 13, % 1300
depth    = 3   % 300
] ;

\mt_registerglyph [
  category = "test",
  unicode  = 125,
  code     = "draw TestGlyphRB ;",
  width    = 15,
  height   = 10,
  depth    = 2
] ;

\mt_registerglyph [
  category = "test",
  unicode  = "/",
  code     = "draw TestGlyphFS ;",
  width    = 15,
  height   = 10,
  depth    = 2
] ;

```

\stopMPcalculation

We now define a font. We always use a font as starting point which has the advantage that we always get something reasonable when we test. Of course you can use this mps font feature with other fonts too.

```
\definefontfeature[metapost][metapost=test] % or: mps={category=test}
```

```
\definefont[MyFontA][Serif*metapost @ 10bp]
```

```
\definefont[MyFontB][Serif*metapost @ 12bp]
```

These fonts can now be used:

```
\MyFontA \dorecurse{20}{\{ /#1/ \} }\par
```

```
\MyFontB \dorecurse{20}{\{ /#1/ \} }\par
```

We get some useless text but it demonstrates the idea:

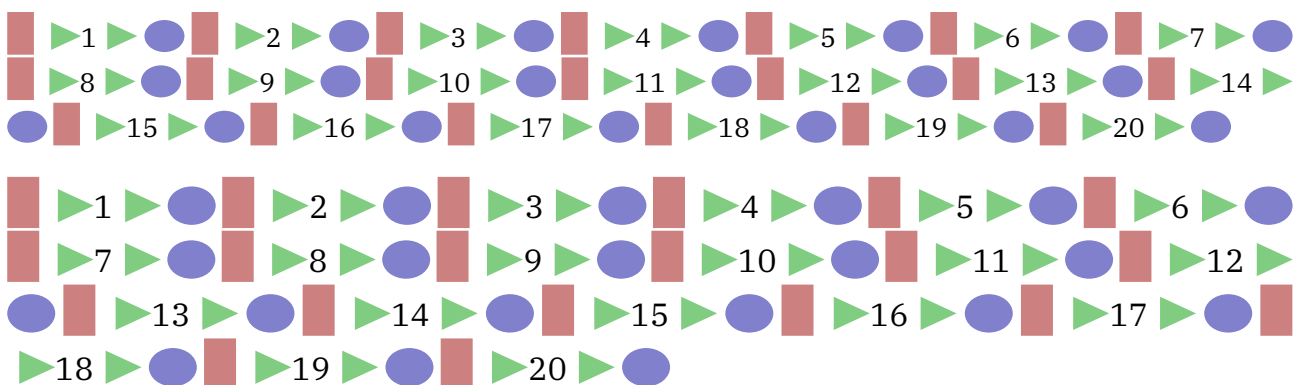

If you know a bit more about ConT_EXt you could think: so what, wasn't this already possible? Sure, there are various ways to achieve similar effects, but the method described here has a few advantages: it's relatively easy and we're talking about real fonts here. This means that using the shapes for characters is pretty efficient.

A more realistic example is given next. It is a subset of what is available in the ConT_EXt core.

```
\startMPcalculation{simplefun}

  pen SymbolPen ; SymbolPen := pencircle scaled 1/4 ;

  vardef SymbolBullet =
    fill unitcircle scaled 3 shifted (1.5,1.5) withpen SymbolPen
  enddef ;
  vardef SymbolSquare =
    draw unitsquare scaled (3-1/16) shifted (1.5,1.5) withpen SymbolPen
  enddef ;
  vardef SymbolBlackDiamond =
    fillup unitdiamond scaled (3-1/16) shifted (1.5,1.5) withpen SymbolPen
  enddef ;
  vardef SymbolNotDef =
    draw center unitcircle
      scaled 3
      shifted (1.5,1.5)
      withpen SymbolPen scaled 4
  enddef ;

  lmt_registerglyphs [
    name      = "symbols",
    units     = 10,
    usecolor  = true,
    width     = 6,
    height    = 6,
    depth     = 0,
    code      = "SymbolNotDef ;",
  ] ;

  lmt_registerglyph [ category = "symbols", unicode = "0x2022",
    code = "SymbolBullet ;"
  ] ;
  lmt_registerglyph [ category = "symbols", unicode = "0x25A1",
    code = "SymbolSquare ;"
  ] ;
  lmt_registerglyph [ category = "symbols", unicode = "0x25C6",
    code = "SymbolBlackDiamond ;"
  ] ;
\stopMPcalculation
```

We could use these symbols in for instance itemize symbols. You might notice the potential difference in bullets:

```
\definefontfeature[metapost][metapost=symbols]
```

```
\definefont[MyFont] [Serif*metapost sa 1]
```

```
\startitemize[packed]
```

```
\startitem {\MyFont
```

• } \quad Regular rendering. \stopitem

```
\startitem {\MyFont\red
```

• } \quad Rendering with color.

```
\stopitem
```

```
\startitem {\MyFont\blue\showglyphs  
shown. \stopitem
```

• } \quad Idem but with boundingboxes

```
\stopitemize
```

- • ◻ • Regular rendering.
- • ◻ • Rendering with color.
- ◻ ◻ ◻ Idem but with boundingboxes shown.

When blown up, these symbols look as follows:

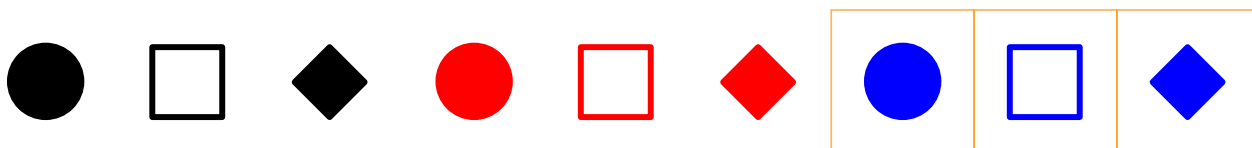

You can use these tricks with basically any font, so also with math fonts. However, at least for now, you need to define these before the font gets loaded.

```
\startMPcalculation{simplefun}
```

```
pen KindergartenPen ; KindergartenPen := pencircle scaled 1 ;
```

```
% 10 x 10 grid
```

```
vardef KindergartenEqual =
```

```
draw image
```

```
(
```

```
draw (2,6) -- (9,5) ;
```

```
draw (2,4) -- (8,3) ;
```

```
)
```

```
shifted (0,-2)
```

```
withpen KindergartenPen
```

```
withcolor "KindergartenEqual"
```

```
enddef ;
```

```
vardef KindergartenPlus =
```

```
draw image
```

```
(
```

```
draw (1,4) -- (9,5) ;
```

```
draw (4,1) -- (5,8) ;
```

```
)
```

```
shifted (0,-2)
```

```
withpen KindergartenPen
```

```
withcolor "KindergartenPlus"
```

```

enddef ;
vardef KindergartenMinus =
    draw image
    (
        draw (1,5) -- (9,4) ;
    )
    shifted (0,-2)
    withpen KindergartenPen
    withcolor "KindergartenMinus"
enddef ;
vardef KindergartenTimes =
    draw image
    (
        draw (2,1) -- (9,8) ;
        draw (8,1) -- (2,8) ;
    )
    shifted (0,-2)
    withpen KindergartenPen
    withcolor "KindergartenTimes"
enddef ;
vardef KindergartenDivided =
    draw image
    (
        draw (2,1) -- (8,9) ;
    )
    shifted (0,-2)
    withpen KindergartenPen
    withcolor "KindergartenDivided"
enddef ;

lmt_registerglyphs [
    name      = "kindergarten",
    units     = 10,
    % usecolor = true,
    width     = 10,
    height    = 8,
    depth     = 2,
] ;

lmt_registerglyph [ category = "kindergarten", unicode = "0x003D",
    code = "KindergartenEqual"
] ;
lmt_registerglyph [ category = "kindergarten", unicode = "0x002B",
    code = "KindergartenPlus"
] ;
lmt_registerglyph [ category = "kindergarten", unicode = "0x2212",
    code = "KindergartenMinus"
] ;
lmt_registerglyph [ category = "kindergarten", unicode = "0x00D7",

```

```

        code = "KindergartenTimes"
    ] ;
    \mt_registerglyph [ category = "kindergarten", unicode = "0x002F",
        code = "KindergartenDivided"
    ] ;

```

\stopMPcalculation

We also define the colors. If we leave `usecolor` to true, the text colors will be taken.

```

\definecolor[KindergartenEqual] [darkgreen]
\definecolor[KindergartenPlus] [darkred]
\definecolor[KindergartenMinus] [darkred]
\definecolor[KindergartenTimes] [darkblue]
\definecolor[KindergartenDivided] [darkblue]

\definefontfeature[mathextra] [metapost=kindergarten]

```

Here is an example:

```
\switchtobodyfont[cambria]
```

```
$ y = 2 \times x + a - b / 3 $
```

Scaled up:

$$y = 2 \times x + a - b / 3$$

Of course this won't work out well (yet) with extensible yet, due to related definitions for which we don't have an interface yet. There is one thing that you need to keep in mind: the fonts are flushed when the document gets finalized so you have to make sure that colors are defined at the level that they are still valid at that time. So best put color definitions like the above in the document style.

This is an experimental interface anyway so we don't explain the parameters yet as there might be more of them.

Sometimes examples can be made from answers to questions on the mailing list, like the following:

```

\startMPcalculation{simplefun}
  \vardef QuotationDash =
    \draw image (
      \interim \linecap := squared ;
      \save l ; l := 0.2 ;
      \draw (l/2,2) -- (15-l/2,2) \withpen pencircle scaled l ;
    )
  \enddef ;

\mt_registerglyphs [
  name      = "symbols",
  units     = 10,

```

```
usecolor = true,  
width    = 15,  
height   = 2.1,  
depth    = 0,  
] ;
```

```
lmt_registerglyph [ category = "symbols", unicode = "0x2015", code = "  
QuotationDash ;" ] ;
```

\stopMPcalculation

\definefontfeature[default][default][metapost=symbols]

Of course you need to figure out how to enter the equivalent of `\char "2015` and/or the font used in your editor should have that character too. Here the wide dash is about twice the `\emdash`.

17 Color

17.1 Lab colors

There are by now plenty of examples made by users that use color and MetaFun provides all kind of helpers. So do we need more? When I play around with things or when users come with questions that then result in a nice looking graphic, the result might en dup as example of coding. The following is an example of showing of colors. We have a helper that goes from a so called lab specification to rgb and it does that via xyz transformations. It makes no real sense to interface this beyond this converter. We use this opportunity to demonstrate how to make an interface.

```
\startMPdefinitions
  vardef cielabmatrix(expr l, mina, maxa, minb, maxb, stp) =
    image (
      for a = mina step stp until maxa :
        for b = minb step stp until maxb :
          draw (a,b) withcolor labtorgb(l,a,b) ;
        endfor ;
      endfor ;
    )
  enddef ;
\stopMPdefinitions
```

Here we define a macro that makes a color matrix. It can be used as follows

```
\startcombination[nx=4,ny=1]
  {\startMPcode draw cielabmatrix(20, -100, 100, -100, 100, 5) ysized 35mm
    withpen pencircle scaled 2.5 ; \stopMPcode} {\type {l = 20}}
  {\startMPcode draw cielabmatrix(40, -100, 100, -100, 100, 5) ysized 35mm
    withpen pencircle scaled 2.5 ; \stopMPcode} {\type {l = 40}}
  {\startMPcode draw cielabmatrix(60, -100, 100, -100, 100, 5) ysized 35mm
    withpen pencircle scaled 2.5 ; \stopMPcode} {\type {l = 60}}
  {\startMPcode draw cielabmatrix(80, -100, 100, -100, 100, 5) ysized 35mm
    withpen pencircle scaled 2.5 ; \stopMPcode} {\type {l = 80}}
\stopcombination
```

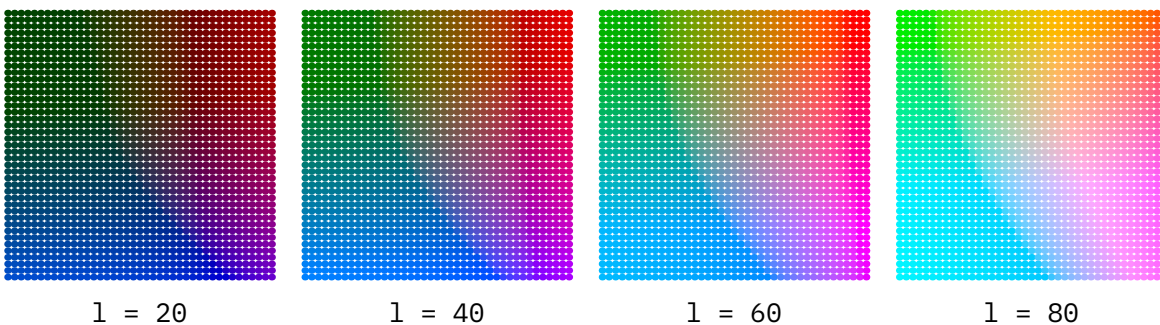

One can of course mess around a bit:

```
\startcombination[nx=4,ny=1]
```

```

{\startMPcode draw cielabmatrix(20, -100, 100, -100, 100, 10) ysize 35mm
  randomized 1 withpen pensquare scaled 4 ; \stopMPcode} {\type {l = 20}}
{\startMPcode draw cielabmatrix(40, -100, 100, -100, 100, 10) ysize 35mm
  randomized 1 withpen pensquare scaled 4 ; \stopMPcode} {\type {l = 40}}
{\startMPcode draw cielabmatrix(60, -100, 100, -100, 100, 10) ysize 35mm
  randomized 1 withpen pensquare scaled 4 ; \stopMPcode} {\type {l = 60}}
{\startMPcode draw cielabmatrix(80, -100, 100, -100, 100, 10) ysize 35mm
  randomized 1 withpen pensquare scaled 4 ; \stopMPcode} {\type {l = 80}}
\stopcombination

```

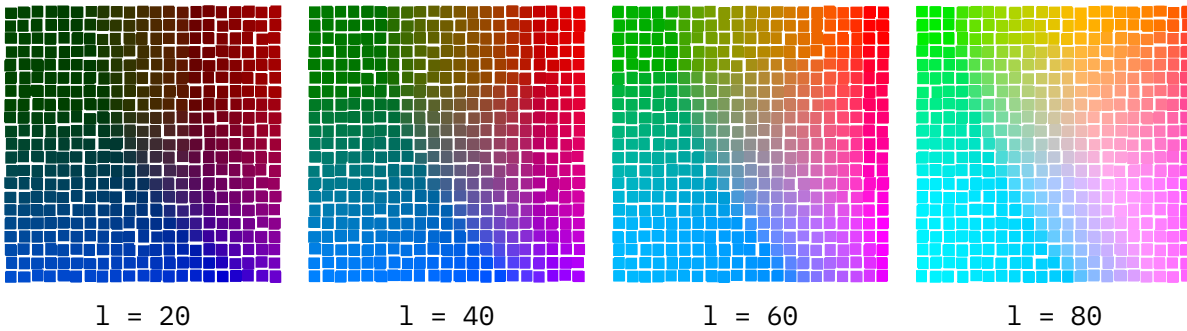

Normally, when you don't go beyond this kind of usage, a simple macro like the above will do. But when you want to make something that is upward compatible (which is one of the principles behind the Con-TeXt user interface(s), you can do this:

```

\startcombination[nx=4,ny=1]
  {\startMPcode draw lmt_labtorgb [ l = 20, step = 20 ] ysize 35mm withpen
    pencircle scaled 8 ; \stopMPcode} {\type {l=20}}
  {\startMPcode draw lmt_labtorgb [ l = 40, step = 20 ] ysize 35mm withpen
    pencircle scaled 8 ; \stopMPcode} {\type {l=40}}
  {\startMPcode draw lmt_labtorgb [ l = 60, step = 20 ] ysize 35mm withpen
    pencircle scaled 8 ; \stopMPcode} {\type {l=60}}
  {\startMPcode draw lmt_labtorgb [ l = 80, step = 20 ] ysize 35mm withpen
    pencircle scaled 8 ; \stopMPcode} {\type {l=80}}
\stopcombination

```

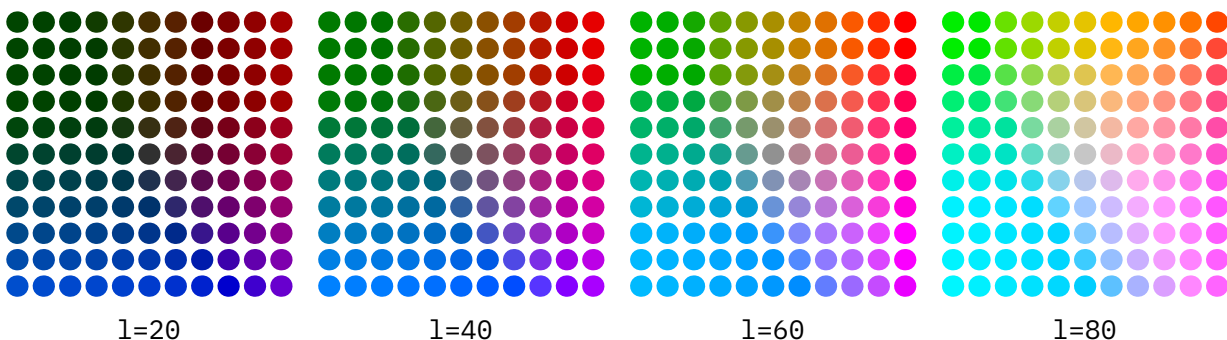

This is a predefined macro in the reserved `lmt_` namespace (don't use that one yourself, create your own). First we preset the possible parameters:

```

presetparameters "labtorgb" [
  mina = -100,

```

```

maxa = 100,
minb = -100,
maxb = 100,
step = 5,
l     = 50,
] ;

```

Next we define the main interface macro:

```
def lmt_labtorgb = applyparameters "labtorgb" "lmt_do_labtorgb" enddef ;
```

Last we do the actual implementation, which looks a lot like the one we started with:

```
vardef lmt_do_labtorgb =
  image (
    pushparameters "labtorgb" ;
    save l ; l := getparameter "l" ;
    for a = getparameter "mina" step getparameter "step"
      until getparameter "maxa" :
      for b = getparameter "minb" step getparameter "step"
        until getparameter "maxb" :
        draw (a,b) withcolor labtorgb(l,a,b) ;
      endfor ;
    endfor ;
    popparameters ;
  )
enddef ;
```

Of course we can now add all kind of extra features but this is what we currently have. Maybe this doesn't belong in the MetaFun core but it's not that much code and a nice demo. After all, there is much in there that is seldom used.

A perceptive color space that uses the lab model is lhc. Here is an example of how that can be used:

```
\startMPdefinitions
```

```
vardef lhc_colorcircle(expr l, c, n) =
  image (
    save p, h ; path p ; numeric h ;
    p := arcpointlist n of fullcircle ;
    for i within p :
      h := i*360/n ;
      draw
        pathpoint scaled 50
        withpen pencircle scaled (120/n)
        withcolor lhc_torgb(l,c,h) ;
      draw
        texttext ("\tt\b" & decimal h)
        scaled .4
        shifted (pathpoint scaled 50)
        withcolor white ;
    endfor ;
  )

```

```

)
enddef ;
\stopMPdefinitions

```

Of course you can come up with another representation than this but here is how it looks:

```

\startMPcode
draw image (
  draw lchcolorcircle(75,100,24) ;
  draw lchcolorcircle(50,100,24) scaled .75 ;
  draw lchcolorcircle(25,100,24) scaled .50 ;
) ysized 4cm ;
\stopMPcode

```

You can get rather nice color pallets by manipulating the axis without really knowing what color you get. The h value is in angles and shown inside the circles.

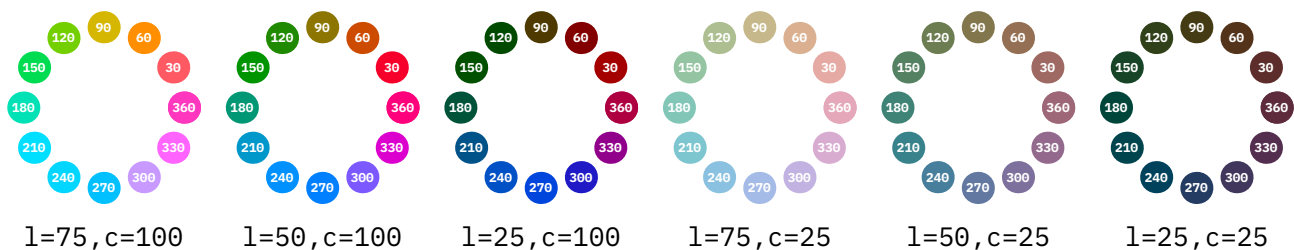

Of course we can again wrap this into a parameter driven macro, this time `lmt_lchcircle` which accepts `l`, `c`, `steps` and a `labels` boolean.

17.2 Transparency

Although transparency is independent from color we discuss one aspect here. Where color is sort of native to MetaPost, especially when we talk `rgb` and `cmyk`, other color spaces are implemented using so called `prescripts`, think “information bound to paths and related wrappers”.

When you do this:

```

\startMPcode
path c ; c := fullcircle scaled 1cm ;
picture p ; p := image (
  fill c shifted ( 0mm,0) withcolor "darkred" ;
  fill c shifted ( 5mm,0) withcolor "darkgreen" ;
  fill c shifted (10mm,0) withcolor "darkblue" ;
) ;

draw p ; draw p shifted (3cm,0) withcolor "middlegray" ;
\stopMPcode

```

You will notice that the picture gets recolored so the color properties set on the picture are applied to separate elements that make it. A picture itself is actually just a list of objects and it has no properties of its own. A way around this is to wrap it in a `group`, `bound` or `clip` which basically means something:

begin, list of objects, end. By putting properties on the wrapper we can support features that apply to what gets wrapped without adapting the properties directly.



Because transparency is also implemented with prescripts we have a problem: should it apply to the wrapper or to everything? In the LuaTeX version of the MetaPost library the scripts get assigned to the first element that supports them and because there only paths can have these properties, you cannot simply change the transparency without looping over the picture and redraw it.

\startMPcode

```
picture q ; q := image (
  fill c shifted ( 0mm,0) withcolor "darkcyan" withtransparency (1,.5);
  fill c shifted ( 5mm,0) withcolor "darkmagenta" withtransparency (1,.5);
  fill c shifted (10mm,0) withcolor "darkyellow" withtransparency (1,.5);
) ;
```

```
draw q ; draw q shifted (3cm,0) withtransparency (1,.25) ;
```

\stopMPcode

In LuaMetaTeX we have a way to assign the properties to the elements so we get three less transparent circles:



In MkIV only the first circle becomes lighter.

\startMPcode

```
picture r ; r := image (
  draw p ;
  draw q shifted (7cm,0cm) ;
) ;
```

```
draw r ;
```

```
draw r shifted (3cm,0) withtransparency (1,.75) ;
```

\stopMPcode

This example shows that when we draw p and q we get the elements at the same level (flattened) so we can indeed apply the transparency to all of them.



So, keep in mind that this only works in MkXL and not in MkVI (unless we also upgrade LuaTeX to support this).

17.3 Surrounding color

Here is an example that shows how to make a graphic listen to the current color:

```
\startcolor[blue]
  blue before
  \startMPcode
    setbackendoption "noplugins" ;
    fill fullcircle xscaled 3EmWidth yscaled 1.5ExHeight ;
  \stopMPcode\space
  blue after
\stopcolor
```

This backend option disables *all* additional features so it will only work for for relative simple graphics. There might be more detailed control in the future.

blue before  blue after

18 Lines

We assume that when you arrived here you already know how to deal with drawing lines including the way they get connected. When you draw a line some properties are controlled by variables which forces you to save existing values when you temporarily adapts them.

```
\startMPcode
draw (0, 0) -- (20, 0) withcolor "darkyellow" ;
draw (0, -1) -- (20, -1) withlinecap butt withcolor "darkred" ;
draw (0, -2) -- (20, -2) withlinecap squared withcolor "darkgreen" ;
draw (0, -3) -- (20, -3) -- (0, -4) withlinejoin squared withcolor "darkblue" ;
\stopMPcode
```

These with features are a LuaMetaTeX extension:

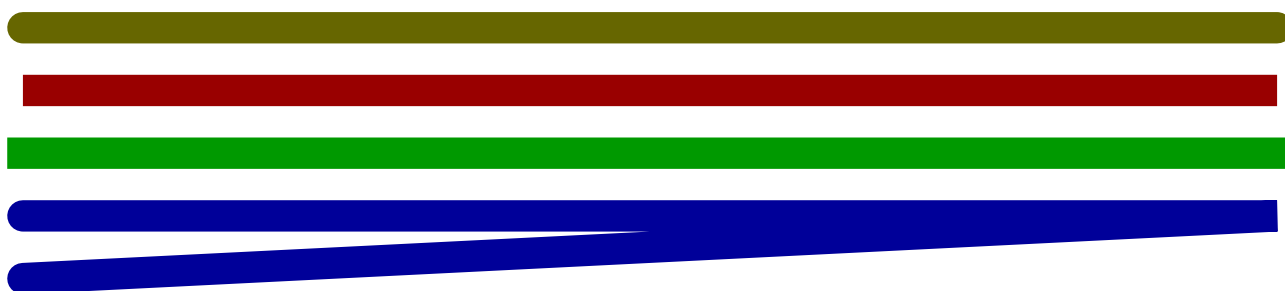

19 Paths

19.1 Introduction

In the end MetaPost is all about creating (beautiful) paths. In this chapter we introduce some extensions to the engine that can be of help when constructing paths. Some relate to combining paths segments, others to generating the points.

19.2 Cycles

The cycle commands closes a path: the end gets connected to the start. One way to construct a path stepwise is using a for loop, as in:

```
\startMPcode
draw (
  (0,sin(0)) for i=pi/20 step pi/20 until 2pi :
    .. (i,sin(i))
  endfor
) xysized(8cm,2cm)
withpen pencircle scaled 1mm
withcolor "darkred" ;
\stopMPcode
```



This looks kind of ugly because we need to make sure that we only put the .. between points. If we have a closed path we can do this:

```
\startMPcode
draw (
  for i=0 step pi/20 until 2pi :
    (i,sin(i)) ..
  endfor cycle
) xysized(8cm,2cm)
withpen pencircle scaled 1mm
withcolor "darkblue" ;
\stopMPcode
```

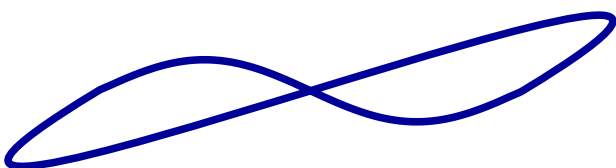

But that is not what we want here. It is for this reason that we have a different operator, one that closes a path without cycling:

```
\startMPcode
draw (
  for i=0 step pi/20 until 2pi :
    (i,sin(i)) ..
  endfor nocycle
) xysized(8cm,2cm)
withpen pencircle scaled 1mm
withcolor "darkgreen" ;
\stopMPcode
```

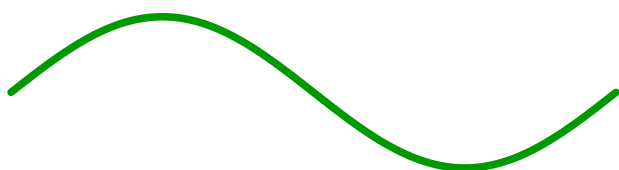

19.3 Combining paths

The & concat operator requires the last point of the previous and the first point of the current path to be the same. This restriction is lifted with the &&, &&& and &&&& commands.

```
\startMPcode
def Example(expr p, q) =
  draw image (
    drawpathonly (p && q) shifted ( 0u,0) ;
    drawpathonly (p &&& q) shifted ( 5u,0) ;
    drawpathonly (p &&&& q) shifted (10u,0) ;
  ) ;
enddef ;

path p[] ; numeric u ; u := 1cm ;
p[1] := (0u,0u) -- (1u,0u) -- (1u,1u) ;
p[2] := (1u,1u) -- (2u,1u) -- (2u,0u) ;

Example(p[1], p[2]) ;

Example(p[1] shifted (0u,-2u), p[2] shifted (1u,-2u)) ;
\stopMPcode
```

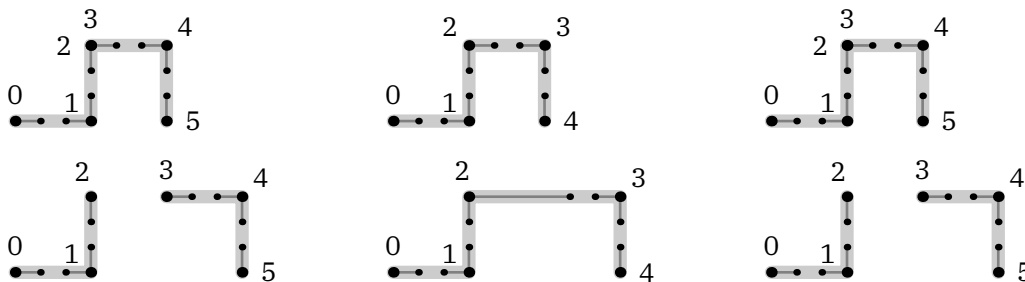

The precise working can be best be seen from what path we get. The single ampersand just does a concat but issues an error when the paths don't touch so we leave that one out.

\startMPdefinitions

```

path p, q, r ;
p := (0,0) -- (1,0) ;
q := (2,0) -- (3,0) ;
r := (1,0) -- (3,0) ;
vardef Example(expr p) =
  % show (p);
  drawpathonly p scaled 4cm ;
enddef ;
\stopMPdefinitions

```

This gives us:



```

(0,0) .. controls (0.33,0) and (0.67,0) .. % p && q
(1,0) {end} .. controls (2, 0) and (1, 0) ..
(2,0) {begin} .. controls (2.33,0) and (2.67,0) ..
(3,0)

```



```

(0,0) .. controls (0.33,0) and (0.67,0) .. % p && r
(1,0) {end} .. controls (1, 0) and (1, 0) ..
(1,0) {begin} .. controls (1.67,0) and (2.33,0) ..
(3,0)

```



```

(0,0) .. controls (0.33,0) and (0.67,0) .. % p &&& q
(1,0) .. controls (2.33,0) and (2.67,0) ..
(3,0)

```



```

(0,0) .. controls (0.33,0) and (0.67,0) .. % p &&& r
(1,0) .. controls (1.67,0) and (2.33,0) ..
(3,0)

```



```

(0,0) .. controls (0.33,0) and (0.67,0) .. % p &&&& q
(1,0) {end} .. controls (2, 0) and (1, 0) ..
(2,0) {begin} .. controls (2.33,0) and (2.67,0) ..
(3,0)

```



```
(0,0) .. controls (0.33,0) and (0.67,0) .. % p &&&& r
(1,0) {end} .. controls (1, 0) and (1, 0) ..
(1,0) {begin} .. controls (1.67,0) and (2.33,0) ..
(3,0)
```

If we have one (concat) ampersand we check if the paths touch, error or move on. If we have three (tolerant concat) or four (tolerant append) ampersands we check if the end and begin are the same and if so, we remove one and set the controls points halfway, and then degrade to one (concat) or two (append) ampersands. Finally when (then) we have one ampersand (concat) we connect with some curl magic but when we have two (append) we connect without the curl magic: we let the left and right control points be the points.

Here is another example of usage. Watch how &&& doesn't influence an already closed curve.

```
\startMPcode
path p[] ;

p[1] := (0,0) -- (100,0) -- (100,100) ; for i=2 upto 5 : p[i] := p[1] ; endfor ;

p[1] := p[1] -- cycle ; p[1] := p[1] -- cycle ; p[1] := p[1] -- cycle ;
p[2] := p[2] -- cycle ; p[2] := p[2] &&& cycle ; p[2] := p[2] &&& cycle ;
p[3] := p[3] -- cycle ; p[3] := p[3] &&&& cycle ; p[3] := p[3] &&&& cycle ;
p[4] := p[4] &&& cycle ;
p[5] := p[5] &&&& cycle ;

for i=1 upto 5 :
  % show(p[i]) ;
  fill p[i] shifted (i*110,0) withcolor "middlegray" ;
  draw p[i] shifted (i*110,0) withcolor "darkred" withpen pencircle scaled 5 ;
endfor ;
currentpicture := currentpicture xsize TextWidth ;
\stopMPcode
```

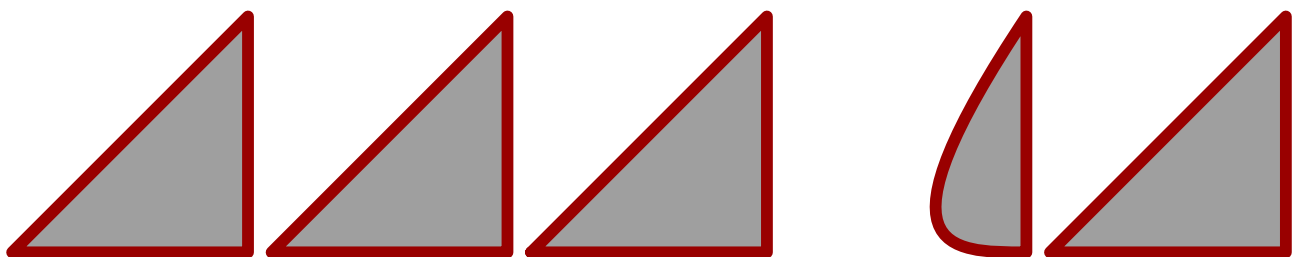

The paths are, here shown with less precision:

```
(0,0) .. controls (33.33,0) and (66.67,-0)
.. (100,0) .. controls (100,33.33) and (100,66.67)
.. (100,100) .. controls (66.67,66.67) and (33.33,33.33)
.. (0,0) .. controls (0,0) and (0,0)
.. (0,0) .. controls (0,0) and (0,0)
```

```

.. cycle

(0,0) .. controls (33.33,0) and (66.67,-0)
.. (100,0) .. controls (100,33.33) and (100,66.67)
.. (100,100) .. controls (66.67,66.67) and (33.33,33.33)
.. cycle

(0,0) {begin} .. controls (33.33,0) and (66.67,-0)
.. (100,0) .. controls (100,33.33) and (100,66.67)
.. (100,100) .. controls (66.67,66.67) and (33.33,33.33)
.. (0,0) {end} .. controls (0,0) and (0,0) % duplicate {end} is
.. (0,0) {end} .. controls (0,0) and (0,0) % sort of an error
.. cycle

(100,100) .. controls (33.33,0) and (66.67,-0)
.. (100,0) .. controls (100,33.33) and (100,66.67)
.. cycle

(0,0) {begin} .. controls (33.33,0) and (66.67,-0)
.. (100,0) .. controls (100,33.33) and (100,66.67)
.. (100,100) {end} .. controls (0,0) and (100,100)
.. cycle

```

These somewhat complicated rules also relate to the intended application: the backend can apply `fill` or `eofill` in which case also cycles are involved as the following examples demonstrate:

```
\startMPdefinitions
```

```

path p, q, r ;
p := fullcircle ;
q := reverse fullcircle ;
r := fullcircle shifted (1/2,0) ;
vardef Example(expr p) =
  image (
    eofill p scaled 4cm withcolor "middlegray" ;
    drawpathonly p scaled 4cm ;
  )
enddef ;

```

```
\stopMPdefinitions
```

```
\startMPcode
```

```

  draw Example(p &&& q &&& cycle) ;
  draw Example(p &&& cycle &&& q &&& cycle) shifted (8cm,0) ;
\stopMPcode

```

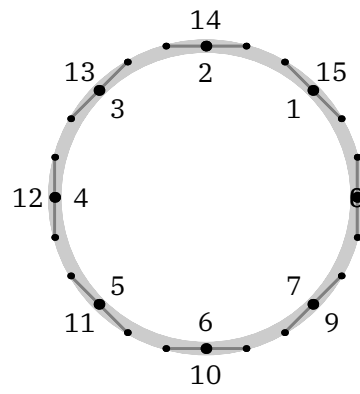
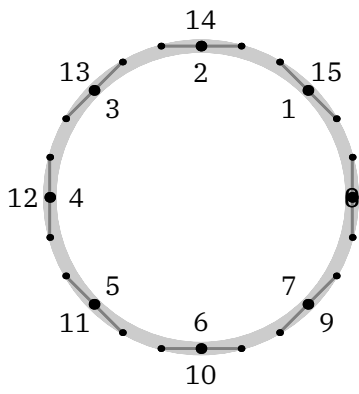

```

\startMPcode
  draw Example(p &&&& r &&& cycle) ;
  draw Example(p &&&& cycle &&& r &&& cycle) shifted (8cm,0) ;
\stopMPcode

```

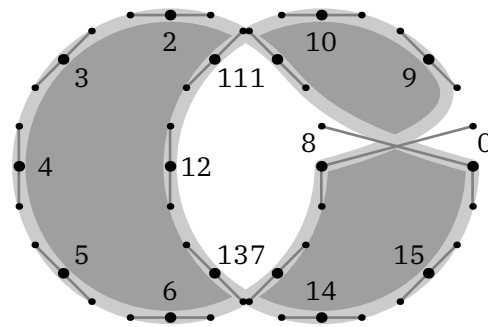
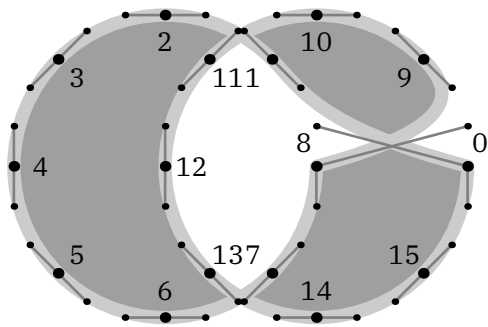

```

\startMPcode
  draw Example(p &&&& q &&&& cycle) ;
  draw Example(p &&&& cycle &&&& q &&&& cycle) shifted (8cm,0) ;
\stopMPcode

```

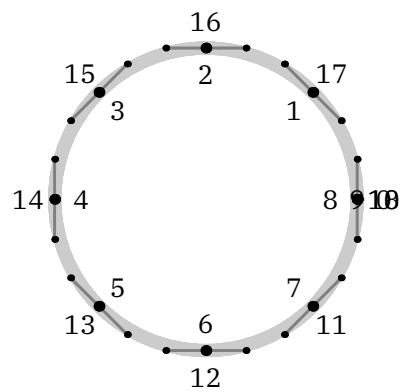
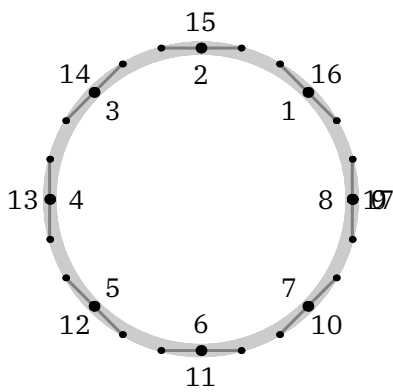

```

\startMPcode
  draw Example(p &&&& r &&&& cycle) ;
  draw Example(p &&&& cycle &&&& r &&&& cycle) shifted (8cm,0) ;
\stopMPcode

```

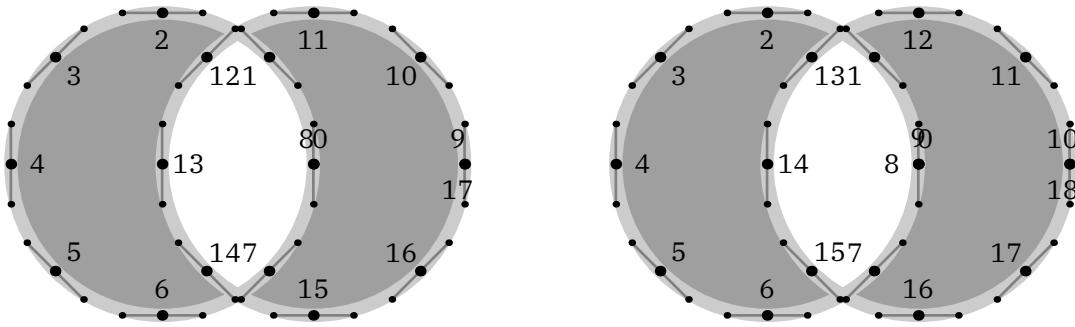

19.4 Implicit points

In the MetaPost library that comes with LuaMetaTeX we have a few extensions that relate to paths. You might wonder why we need these but some relate to the fact that paths can be generated programmatically. A prominent operator (or separator) is `..` and contrary to what one might expect the frequently used `--` is a macro:

```
def -- = { curl 1 } .. { curl 1 } enddef ;
```

This involves interpreting nine tokens as part of expanding the macro and in practice that is fast even for huge paths. Nevertheless we now have a `--` primitive that involves less interpreting and also avoids some intermediate memory allocation of numbers. Of course you can still define it as macro.

When you look at PostScript you'll notice that it has operators for relative and absolute positioning in the horizontal, vertical or combined direction. In LuaMetaTeX we now have similar operators that we will demonstrate with a few examples.

```
\startMPcode
drawarrow origin
  -- xrelative 300
  -- yrelative 20
  -- xrelative -300
  -- cycle
withpen pencircle scaled 2
withcolor "darkred" ;
\stopMPcode
```



In the next example we show a relative position combined with an absolute and we define them as macros. You basically gets what goes under the name 'turtle graphics':

```
\startMPcode
save h ; def h = -- xrelative enddef ;
save v ; def v = -- yabsolute enddef ;

drawarrow origin
  h 30 v 20 h 30 v 30
  h 30 v 10 h 30 v 50
  h 30 v 60 h 30 v 10
```

```

withpen pencircle scaled 2
withcolor "darkred" ;
\stopMPcode

```

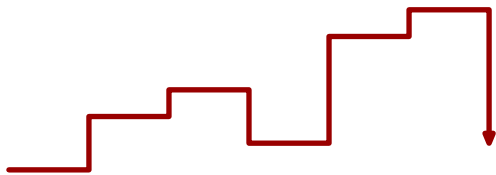

When you provide a pair to `xabsolute` or `yabsolute`, the `xpart` is the (relative) advance and the second the absolute coordinate.

```

\startMPcode
draw origin
  -- yabsolute(10,30)
  -- yabsolute(20,20)
  -- yabsolute(30,10)
  -- yabsolute(40,20)
  -- yabsolute(50,30)
  -- yabsolute(60,20)
  -- yabsolute(70,10)
  -- yabsolute(80,20)
  -- yabsolute(90,30)
withpen pencircle scaled 2
withcolor "darkred" ;
\stopMPcode

```



The `xyabsolute` is sort of redundant and is equivalent to just a pair, but maybe there is a use for it. When the two coordinates are the same you can use a numeric.

```

\startMPcode
draw origin
  -- xyabsolute(10, 10) % -- xyabsolute 10
  -- xyabsolute(20, 10)
  -- xyabsolute(30,-10)
  -- xyabsolute(40,-10)
  -- xyabsolute(50, 10)
  -- xyabsolute(60, 10)
  -- xyabsolute(70,-10)
  -- xyabsolute(80,-10)
withpen pencircle scaled 2
withcolor "darkred" ;
\stopMPcode

```



The relative variant also can take a pair and numeric, as in:

```
\startMPcode
draw origin
  -- xyrelative 10
  -- xyrelative 10
  -- xyrelative(10,-10)
  -- xyrelative(10,-10)
  -- xyrelative 10
  -- xyrelative 10
  -- xyrelative(10,-10)
  -- xyrelative(10,-10)
withpen pencircle scaled 2
withcolor "darkred" ;
\stopMPcode
```



In these examples we used -- but you can mix in .. and control point related operations, although the later is somewhat less intuitive here.

```
\startMPcode
draw yabsolute(10,30)
  .. yabsolute(20,20)
  .. yabsolute(10,10)
  .. yabsolute(20,20)
  .. yabsolute(10,30)
  .. yabsolute(20,20)
  .. yabsolute(10,10)
  .. yabsolute(20,20)
  .. yabsolute(10,30)
withpen pencircle scaled 2
withcolor "darkred" ;
\stopMPcode
```

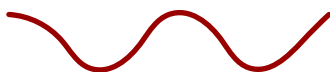

And with most features, users will likely find a use for it:

```
\startMPcode
draw for i=1 upto 5 :
  yabsolute(10,30) ---
  yabsolute(20,20) ...
  yabsolute(10,10) ---
  yabsolute(20,20) ...
endfor nocycle
withpen pencircle scaled 2
withcolor "darkred" ;
\stopMPcode
```



Here is a more impressive example, the result is shown in figure ??:

```

\startMPcode
for n=10 upto 40 :
  path p ; p := (
    for i = 0 step pi/n until pi :
      yabsolute(cos(i)^2-sin(i)^2,sin(i)^2-cos(i)^2) --
    endfor cycle
  ) ;
  draw p
  withpen pencircle scaled 1/20
  withcolor "darkred" withtransparency (1,.25) ;
endfor ;
currentpicture := currentpicture xysized (TextWidth,.25TextWidth) ;
\stopMPcode

```

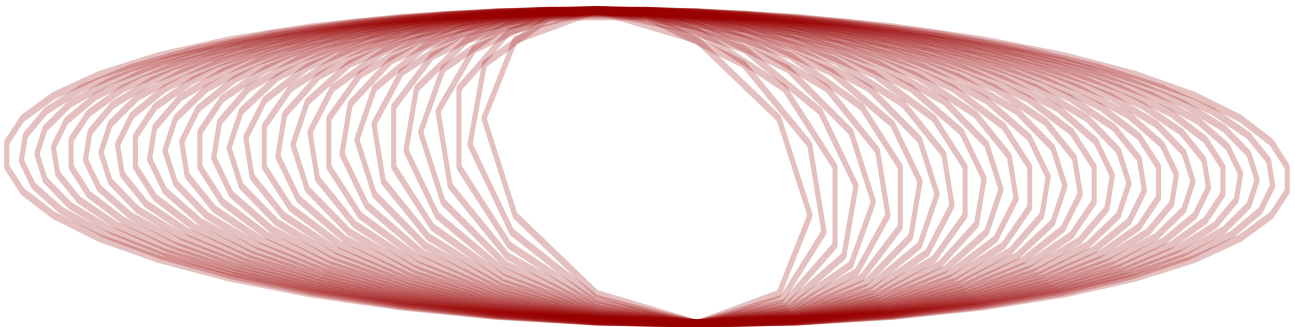

Figure 19.1 Combined relative x and absolute y positioning

19.5 Control points

Most users will create paths by using `...`, `...`, `--` and `---` and accept what they get by the looks. If your expectations are more strict you might use `tension` or `curl` with directions and vectors for the so called control points between connections. In figure 19.2 you see not only controls in action but also two operators that can be used to set the first and second control point. For the record: if you use controls without and the singular pair will be used for both control points.

```

\startMPcode
path p, q, r, s ;

p = origin {dir 25} .. (80,0) .. controls ( 80, 0) and (100,40) .. (140,30)
  .. {dir 0} (180,0) ;
q = origin {dir 25} .. (80,0) .. controls (100,40) and (140,30) .. (140,30)
  .. {dir 0} (180,0) ;
r = origin {dir 25} .. (80,0) .. secondcontrol (100,40) .. (140,30)
  .. {dir 0} (180,0) ;
s = origin {dir 25} .. (80,0) .. firstcontrol (100,40) .. (140,30)
  .. {dir 0} (180,0) ;

```

```

def Example(expr p, t, c) =
  draw p ;
  drawpoints p withcolor "middlegray" ;
  drawcontrollines p withpen pencircle scaled .3 withcolor c ;
  drawcontrolpoints p withpen pencircle scaled 2 withcolor c ;
  label.lft("\smallinfofont current", point 1 of p) ;
  label.top("\smallinfofont next", point 2 of p) ;
  draw thetexttext.rt("\infofont path " & t, (point 3 of p) shifted (5,0)) ;
enddef ;

draw image (
  Example(p, "p", "darkred") ; currentpicture := currentpicture yshifted 50 ;
  Example(q, "q", "darkblue") ; currentpicture := currentpicture yshifted 50 ;
  Example(r, "r", "darkred") ; currentpicture := currentpicture yshifted 50 ;
  Example(s, "s", "darkblue") ; currentpicture := currentpicture yshifted 50 ;
) xsize TextWidth ;
\stopMPcode

```

19.6 Arcs

In PostScript and svg we have an arc command but not in MetaPost. In LMTX we provide a macro that does something similar:

```

\startMPcode
draw
  (0,0) --
  (arc(0,180) scaled 30 shifted (0,30)) --
  cycle
withpen pencircle scaled 2
withcolor "darkred" ;
\stopMPcode

```

The result is not spectacular:



Instead of a primitive with five arguments and the prescribed line drawn from the current point to the beginning of the arc we just use `..`, scaled for the radius, and shifted for the origin. It actually permits more advanced trickery.

```

\startMPcode
draw
  (0,0) ..
  (arc(30,240) xscaled 60 yscaled 30 shifted (0,30)) ..
  cycle
withpen pencircle scaled 2
withcolor "darkred" ;

```

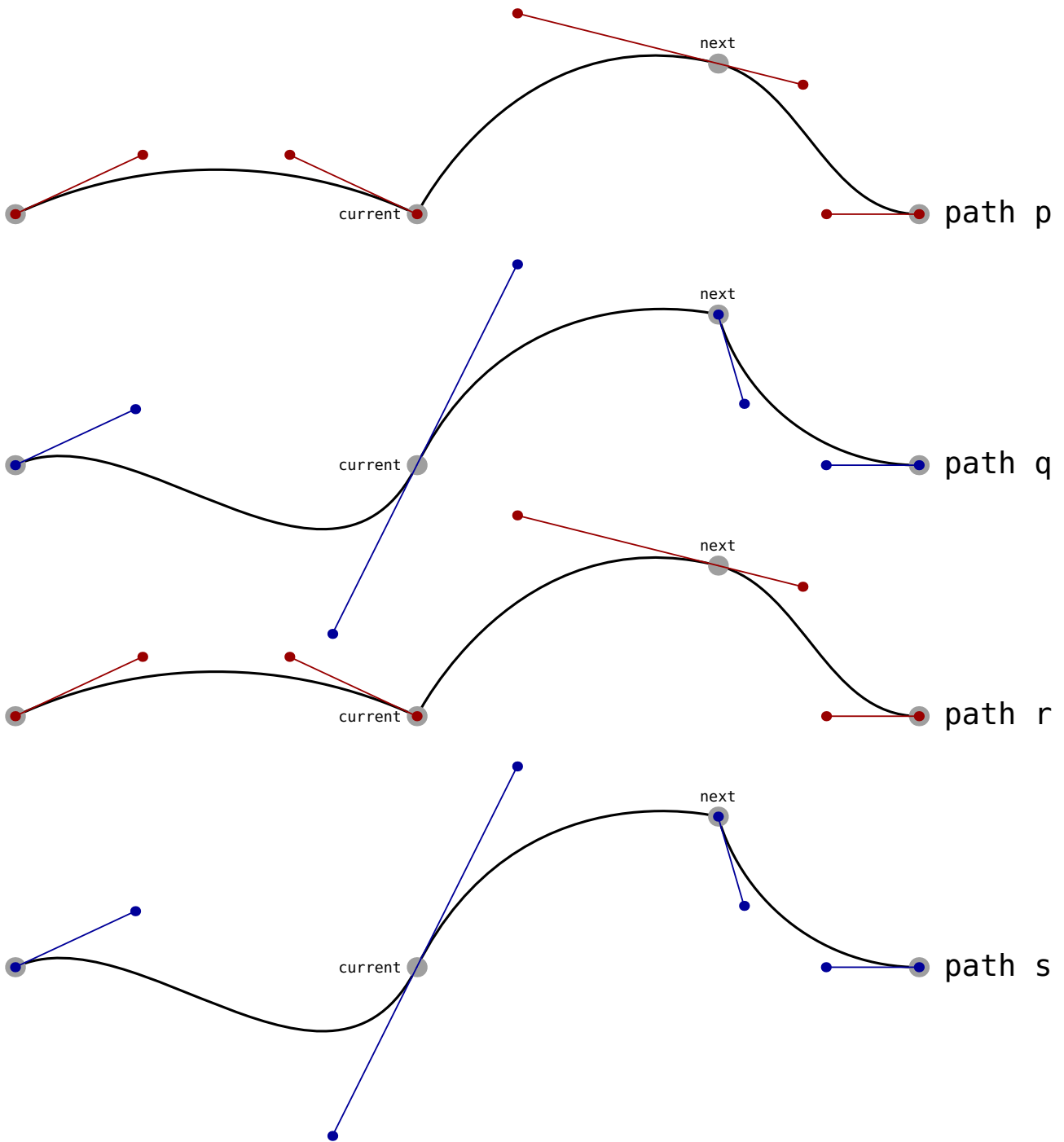

Figure 19.2 Three ways to set the control points.

`\stopMPcode`

Here time we get smooth connections:



but because we scale differently also a different kind of arc: it is no longer a circle segment, which is often the intended use of arc.

19.7 Loops

The MetaPost program is a follow up on MetaFont, which primary target was to design fonts. The paths that make up glyphs are often not that large and because in most cases we don't know in advance how large a path is they are implemented as linked lists. Now consider a large paths, with say 500 knots. The following assignment:

```
pair a ; a := point 359 of p ;
```

has to jump across 358 knots before it reaches the requested point. Let's take an example of drawing a function by (naively) stepping over values:

```
\startMPcode
path p ; p := for i=0 step 4pi/500 until 4pi: (i,sin(i)) -- endfor nocycle ;
p := p xysized(TextWidth,2cm) ;
draw p ;
\stopMPcode
```

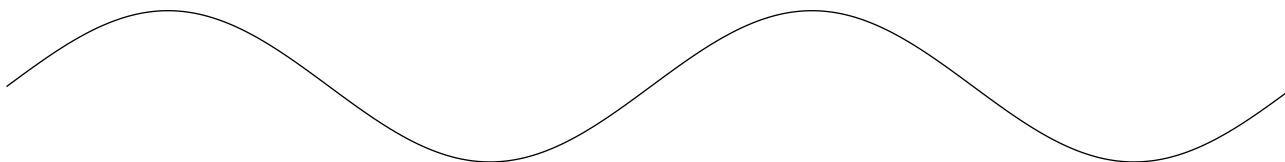

Of course we can just calculate the point directly but here we just want to illustrate a problem.

```
\startMPcode
draw p ; for i=0 step 5 until length(p) :
    drawdot point i of p withpen pencircle scaled 2 ;
endfor ;
\stopMPcode
```

For 500 points, on a modern computer running over the list is rather fast but when we are talking 5000 points it gets noticeable, and given what MetaPost is used for, having many complex graphics calculated at runtime can have some impact on runtime.

Of course we can just calculate the point directly but here we just want to illustrate a problem. Where the previous loop takes 0.002 seconds, the second loop needs 0.001 seconds:

```
\startMPcode
pair p ; for i within p :
    if i mod 5 == 0 :
        drawdot pathpoint withpen pencircle scaled 2 ;
    fi ;
endfor ;
\stopMPcode
```

These numbers are for assigning the point to a pair variable so that we don't take into account the extra drawing (and backend) overhead. The difference in runtime can be neglected but what if we go to 5000 points? Not unsurprisingly we go down from 0.142 seconds to 0.004 seconds. There are plenty examples where runtime can be impacted, for instance when one first takes the `xpart` point `i` and then the `ypart` point `i`.

```

vardef dashing (expr pth, shp, stp) =
  for i within arclist stp of pth :
    shp
      rotated angle(pathdirection)
      shifted pathpoint
    &&
  endfor nocycle
enddef ;

```

With:

```

\startMPcode
path p ; p := unitsquare xysized (TextWidth,1cm) ;
draw p withpen pencircle scaled .2mm withcolor darkblue ;
fill dashing (p, triangle scaled 1mm, 100) && cycle withcolor "darkred" ;
\stopMPcode

```

we get:

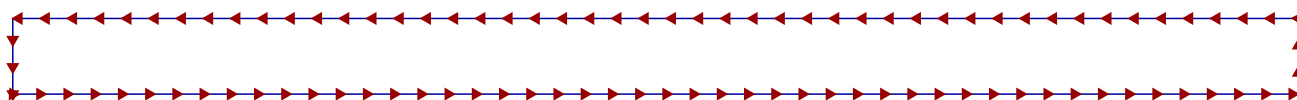

It is worth noticing that the path returned by `dashing` is actually a combined path where the pen gets lifted between the subpaths. This is what the `&&` does. The `nocycle` is there to intercept the last ‘connector’ (which of course could also have been a `--` or `...`). So we end up with an open path, which why in case of a fill we need to close it by `cycle`. In the next example we show all the accessors:

```

\startMPcode[instance=scaledfun]
path p; p := (fullsquare scaled 3 && fullsquare rotated 45 scaled 2 && cycle) ;

for i within p :
  message(
    "index "      & decimal pathindex
    & ", lastindex " & decimal pathlastindex
    & ", length "   & decimal pathlength
    & ", first "    & if pathfirst : "true" else : "false" fi
    & ", last "     & if pathlast : "true" else : "false" fi
    & ", state "    & decimal pathstate % end/begin subpath
    & ", point "    & ddecimal pathpoint
    & ", postcontrol " & ddecimal pathprecontrol
    & ", precontrol " & ddecimal pathpostcontrol
    & ", direction " & ddecimal pathdirection
    & ", delta "     & ddecimal deltapoint 1
  );
endfor ;

eofill p xysized (TextWidth, 2cm) withcolor "darkred" ;
\stopMPcode

```

If you want to see the messages you need to process it yourself, but this is how the ten point shape looks like:

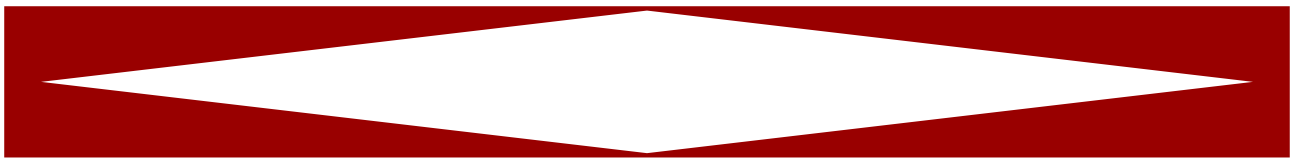

There are more efficient helpers. Some are applied to a path, like in the example below:

```

\startMPcode
path p ; p := fullcircle xyscaled (100,20) ;

draw p withpen pencircle scaled 3 withcolor "middlegray" ;

pickup pencircle scaled 5;

drawdot firstpoint      p withcolor "darkred" ;
drawdot lastpoint       p withcolor "darkgreen" ;

pickup pencircle scaled 3;

drawdot firstprecontrol p withcolor "darkred" ;
drawdot firstpostcontrol p withcolor "darkred" ;
drawdot lastprecontrol  p withcolor "darkgreen" ;
drawdot lastpostcontrol p withcolor "darkgreen" ;

setbounds currentpicture to p enlarged 5 ;
\stopMPcode

```

These mostly make sense in macros that manipulate paths, so for examples you can check their usage in the ConTeXt distribution. In addition there are also `firstdirection`, `lastdirection`, `firstunitdirection`, `lastunitdirection`

```

\startMPcode
path p ; p := fullcircle xyscaled (100,20) ;

draw p withpen pencircle scaled 3 withcolor "middlegray" ;

for i within p :
  drawarrow
    (pathpoint -- 20 * pathunitdirection shifted pathpoint)
    withcolor "darkblue" ;
endfor
setbounds currentpicture to p enlarged 5 ;
\stopMPcode

```

Again, these are mostly meant for extensive path manipulations. There are also `delta*` variants. Anyway, these two examples give us:

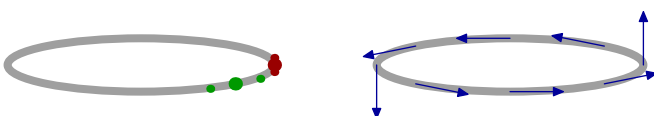

19.8 Randomized paths

When randomizing a path the points move and when such a path has to bound a specific areas that can result in overlap which what is bounded.

```
\startMPcode
path p ; p := fullsquare xyscaled (10cm,2cm) ;
fill p withcolor "darkred" ;
draw p randomized 3mm withpen pencircle scaled 1mm withcolor "middlegray";
setbounds currentpicture to p ;
\stopMPcode
```



Here are two variants that randomize a path but keep the points where they are. They might be better suited for cases where there is text within the area.

```
\startMPcode
path p ; p := fullsquare xyscaled (10cm,2cm) ;
fill p withcolor "darkblue" ;
draw p randomizedcontrols 3mm withpen pencircle scaled 1mm withcolor "middlegray"
";
setbounds currentpicture to p ;
\stopMPcode
```

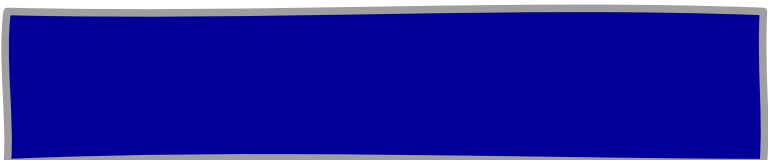

```
\startMPcode
path p ; p := fullsquare xyscaled (10cm,2cm) ;
fill p withcolor "darkyellow" ;
draw p randomrotatedcontrols 15 withpen pencircle scaled 1mm withcolor "
middlegray";
setbounds currentpicture to p ;
\stopMPcode
```



19.9 Connecting

In LuaMetaTeX the -- operator is a primitive, like .. and when exploring this we came up with this example that demonstrates the difference with (still a macro) ---.

```

\startMPcode
path p[] ;
p[1] = origin -- (100, 0) .. (75, 50) .. (50, 100) .. (25, 50) .. cycle ;
p[2] = origin --- (100, 0) .. (75, 50) .. (50, 100) .. (25, 50) .. cycle ;
p[3] = origin -- (100, 0) ... (75, 50) ... (50, 100) ... (25, 50) ... cycle ;
p[4] = origin --- (100, 0) ... (75, 50) ... (50, 100) ... (25, 50) ... cycle ;

draw p[1] withpen pencircle scaled 3bp withcolor "darkblue" ;
draw p[2] withpen pencircle scaled 2bp withcolor "darkyellow" ;
drawpoints p[1] withpen pencircle scaled 3bp withcolor darkred ;

draw image (
  draw p[1] withpen pencircle scaled 4bp withcolor "darkblue" ;
  draw p[2] withpen pencircle scaled 3bp withcolor "darkyellow" ;
  draw p[3] withpen pencircle scaled 2bp withcolor "darkred" ;
  draw p[4] withpen pencircle scaled 1bp withcolor "darkgreen" ;
) shifted (150,0) ;
\stopMPcode

```

Where ... makes a more tight curve, --- has consequences for the way a curve gets connected to a straight line segment.

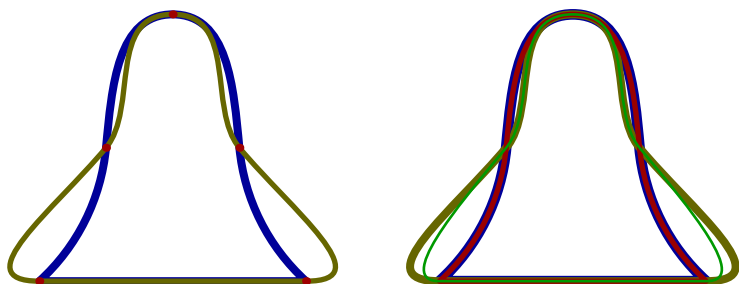

19.10 Curvature

Internally MetaPost only has curves but when a path is output it makes sense to use lines when possible. The ConTeXt backend takes care of that (and further optimizations) but you can check yourself too.

```

\startMPcode
def Test(expr p, c) =
  draw
    p
    withpen pencircle scaled 2mm
    withcolor c ;
  draw
    texttext("\bf " & if not (subpath(2,3) of p hascurvature 0.02) : "not"
      else : "" fi & " curved" )
    shifted center p ;
enddef ;

Test(fullcircle scaled 3cm shifted (0cm,0), "darkred");
Test(fullsquare scaled 3cm shifted (4cm,0), "darkblue");

```

```
Test(fullsquare scaled 3cm shifted (8cm,0) randomizedcontrols 1cm,"darkgreen");
\stopMPcode
```

The `hascurvature` macro is a primary and applies a curvature criterium to a (sub)path. The default tolerance in the backend is 131/65536 or 0.002. The same default is used for eliminating points that ‘are the same’.

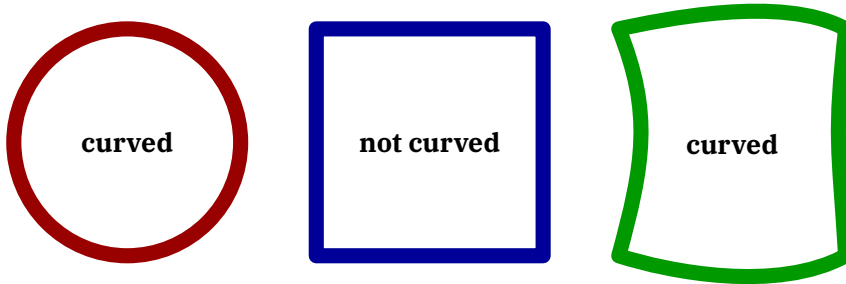

In the rare case that the backend decides for straight lines while actually there is a curve, you can use `withcurvature 1` to bypass the check.

19.11 Joining paths

Say that you have three paths:

```
path p[] ;
p[1] := (0,0) -- (100,0) ;
p[2] := (101,0) -- (100,100) ;
p[3] := (100,101) ;
```

If you join these with:

```
draw p[1] & p[2] & p[3] -- cycle ;
```

You will get an error message telling that the paths don’t have common points so that they can’t be joined. This can be a problem when your snippets are the result of cutting up a path. In practice the difference between the to be joined coordinates is small, so we provide a way to get around this problem:

```
\startMPcode
interim jointolerance := 5eps ;
draw (0,0) -- (100,0) & (100+4eps,0) -- (100,20) & (100,20+2eps) -- cycle
withpen pencircle scaled 2 withcolor "darkred" ;
\stopMPcode
```

Up to the tolerance is accepted as difference in either direction, so indeed we get a valid result:



Larger values can give a more noticeable side effect:

```
\startMPcode
interim jointolerance := 20 ;
draw (0,0) -- (100,0) & (110,10) -- (100,40) & (100,50) -- cycle
```

```

        withpen pencircle scaled 2 withcolor "darkred" ;
\stopMPcode

```

It all depends on your need if this is considered okay:



As with everything $\text{T}_\text{E}\text{X}$ and MetaPost, once you see what is possible it can be abused:

```

\startMPcode
interim jointolerance := 20 ;
randomseed := 10 ;
draw for i=1 upto 200 :
  (i,50 randomized 10) --
endfor nocycle
  withpen pencircle scaled .1 ;
randomseed := 10 ;
draw for i=1 upto 200 :
  (i,50 randomized 10) if odd i : & else : -- fi
endfor nocycle
  withcolor "darkred" ;
\stopMPcode

```

We leave it up to the reader to decide how the red line can be interpreted.

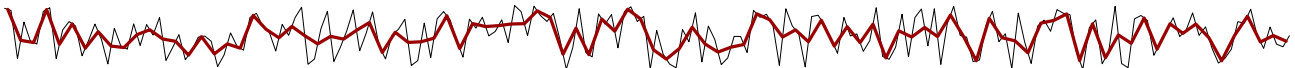

Here is another nice example:

```

\startMPcode
path p[] ;
p[1] := origin -- (100,50) ;
p[2] := (200,50) -- (300,0) ;
draw p[1] && p[2] withpen pencircle scaled 4 withcolor darkgreen ;
draw p[1] -- p[2] withpen pencircle scaled 2 withcolor "orange" ;
interim jointolerance := 100 ;
draw p[1] & p[2] withpen pencircle scaled 1 withcolor "darkblue" ;
\stopMPcode

```

Watch how we get a curve:

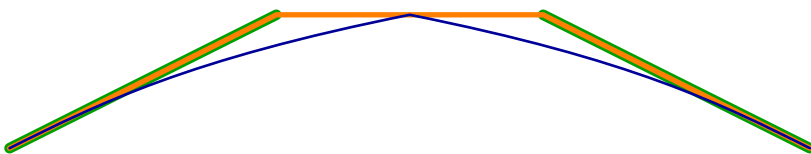

19.12 Dashing

In addition to dashes we provide `withdashes` that distributes the dashes along the path in such a way that the pieces are equivalent.

```
\startMPcode
numeric u ; u := 10pt ;

path piece, impossible ;

piece := (0,2u)
  -- xyrelative ( u, u)
  -- xyrelative ( 4u,-4u)
  -- xyrelative (-4u,-4u)
  -- xyrelative (-2u, 0)
  -- xyrelative ( 4u, 4u)
  -- cycle ;

impossible :=
  piece          &&
  piece rotated 90 &&
  piece rotated 180 &&
  piece rotated 270 ;

draw impossible
  withpen pencircle scaled .5u
  withcolor "darkblue" ;

draw piece
  withdashes .5u
  withpen pencircle scaled .25u
  withcolor white ;
\stopMPcode
```

This turtle graphics example (by Milkael S) also demonstrates appending subpaths to a single path.

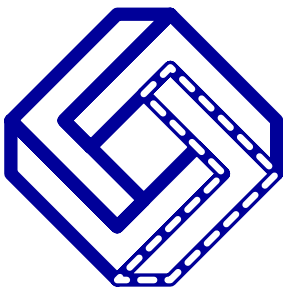

19.13 Segments

Because we can construct a path in segments using `&&` we have methods for accessing these segments. The following example demonstrates how we can access these segments. We define a path that is made from two segments. We `eofill` them, as we do for instance with glyphs in fonts. Here we have two

segments. The segments operators returns the number of segments, and segment returns the subpath range. The subpath operator accepts a numeric in which case it will return the segment.

```

\startMPcode
  path p ; p := fullcircle xysized (TextWidth,2cm) ;
  p := p && p scaled .5;
  eofill p && cycle withcolor "lightgray" ;
  draw
    subpath 1 of p
    withcolor "darkred"
    withpen pencircle scaled 4mm ;
  draw
    subpath 2 of p
    withcolor "darkgreen"
    withpen pencircle scaled 4mm ;
  draw
    subpath (segment 1 of p) of p
    withcolor white
    withpen pencircle scaled 2mm ;
  draw
    subpath (segment 2 of p) of p
    withcolor white
    withpen pencircle scaled 2mm ;
  draw p
    withcolor "darkblue"
    withpen pencircle scaled .75mm ;
  draw texttext("\tx we have " & decimal segments p & " segments");
\stopMPcode

```

In order to let the eofill do its work we have to close the path properly. The next snippet has the same effect:

```

p := p && reverse p scaled 2;
fill p && cycle withcolor "lightgray" ;

```

Anyway, we get this picture:

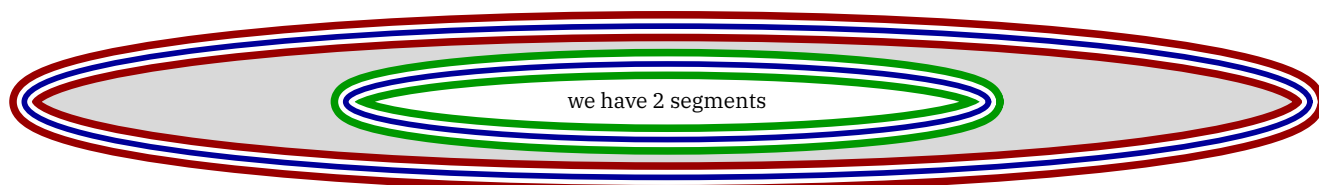

19.14 Checking progress

While constructing a path you have access to the coordinates of the last added point:

```

\startMPcode
  draw (0,0)
  -- (1cm,1cm)

```

```

-- (lastx + 2cm, 1cm)
-- (lastx + 1cm, lasty - 1cm)
-- 2 * lastxy
withpen pencircle scaled 1mm withcolor "darkred" ;
\stopMPcode

```

The not so spectacular result is:



We also have `previousx`, `previousy` and `previousxy` but be aware of the fact that when you consult these after a first knot, these can have a value related to a previous path. This is on purpose because we can use this to pick up a path made from segments. When it has huge (infinite) values that indicates a reset, for instance when we cycle. This might evolve a bit as we proceed.

```

% draw (0,0); uncomment this to see the difference
draw
  (0, 0) -- % after adding the knot:
  hide(message(ddecimal previousxy & " " & ddecimal lastxy))
  (10, 10) -- % after adding the knot:
  hide(message(ddecimal previousxy & " " & ddecimal lastxy))
  (lastx + 20, 10) -- % after adding the knot:
  hide(message(ddecimal previousxy & " " & ddecimal lastxy))
  (lastx + 10, lasty - 10) -- % after adding the knot:
  hide(message(ddecimal previousxy & " " & ddecimal lastxy))
  2 * lastxy
;

```

19.15 Triplets

In a way we can see a triplet as used in `rgb` colors as a three dimensional coordinate and in the future we might actually add some native support for it. For the moment we provide `xpart`, `ypart`, `zpart` and `wpart` for the triplet and quadruplets.

A consequence is that some operations that one would not expect to work on colors, now actually do. So, one can multiply them and for instance apply the `normalize` unary operator.

19.16 Nice to know

It is hard to document every trick which is why users can peek in the source and see what can be done. In figure 19.4 we see a possible application for `round`.

```

\startMPcode
pickup pencircle scaled 2mm
draw (fullcircle scaled 30mm) withcolor "darkred" ;
draw round(fullcircle scaled 30mm) withcolor "white" ;
draw (fullcircle scaled 20mm) withcolor "darkgreen" ;

```

```

draw round(fullcircle scaled 20mm) withcolor "white" ;
\stopMPcode

```

The round command can be applied to various data types, which is true for more such commands. If you miss something, just ask for it.

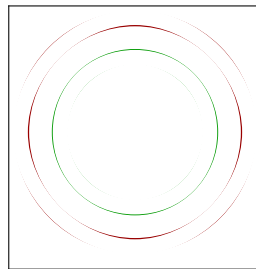

Figure 19.4 An a-typical application of round.

There are some helpers that only make sense in specific situations, take for instance this one:

```

\startMPcode
pickup pencircle scaled 1mm ;
draw sortedpath fullcircle xyscaled (5cm,1cm)
  withcolor "darkred" ;
draw sortedpath fulldiamond xyscaled (5cm,1cm) xshifted 6cm
  withcolor "darkgreen" ;
\stopMPcode

```

Although can use this for special effects, its's main application is in situations where we use a path as a data structure, an efficient collection of points.



Here are some more, can you guess what they are?



Some commands can be improved but best can be left untouched because they might be used in specific situations. The next two cutters are for instance used in a presentation style that already was present in MkII.

```

\startMPcode
def demo (expr p) =
  image (
    drawarrow p scaled 20mm withcolor "darkred" ;
    drawarrow leftpath p scaled 15mm withcolor "darkblue" ;
    drawarrow rightpath p scaled 10mm withcolor "darkgreen" ;
  )
enddef ;

draw demo(fullcircle rotated 90)

```

```

    withpen pencircle scaled 1mm
;
draw demo(fullsquare) xshifted 25mm
    withpen pencircle scaled 1mm
;
draw demo(fullsquare squeezed .1) xshifted 50mm
    withpen pencircle scaled 1mm
;
\stopMPcode

```

As long as you keep in mind that in matters where the first point is, you're probably fine. Also, there might in the meantime be better ways to get the result you want.

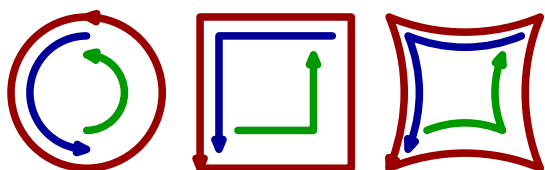

Although you can use `cycle` to close a curve you might want a different solution, like this:

```

\startMPcode
def demo (expr p) =
  image (
    draw closedcurve (p scaled 20mm) withcolor "darkred" ;
    draw (p && cycle) scaled 20mm withcolor "darkblue" ;
    draw p scaled 20mm withcolor "darkgray" ;
  ) withpen pencircle scaled 2mm
enddef ;

draw demo ((0,0) -- (1,0) -- (1,1)) ;
draw demo ((0,0) .. (1,0) .. (1,1)) xshifted 40mm ;
\stopMPcode

```

Such helpers can also be looked at to get ideas of how to manipulate graphics because one easily forget that they are around. If you look at the source you will notice that they are just selectively applied `.. cycle` and `-- cycle` operations.

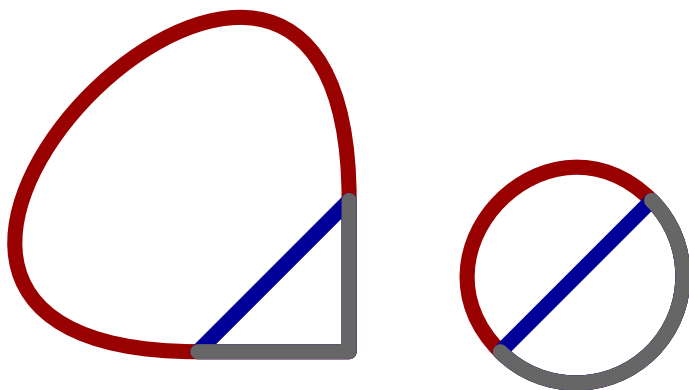

For some trickery normalization can be needed and that is what `xnormalized`, `ynormalized` and `ynormalized` do. Here is an example:

```

\startMPcode
draw fullcircle scaled 2cm
  withpen pencircle scaled 4mm withcolor "lightgray" ;
draw unitcircle scaled 2cm xshifted 3cm
  withpen pencircle scaled 2mm withcolor "lightgray" ;
draw fullcircle scaled 2cm xynormalized (1,1) scaled 2cm
  withpen pencircle scaled 3mm withcolor "darkred" ;
draw unitcircle scaled 2cm xynormalized (1,1) scaled 2cm xshifted 3cm
  withpen pencircle scaled 1mm withcolor "darkgreen" ;

drawdot origin withpen pencircle scaled 2mm ;
drawdot origin xshifted 3cm withpen pencircle scaled 2mm ;
\stopMPcode

```

It also demonstrates the difference between these (predefined) full and unit paths.

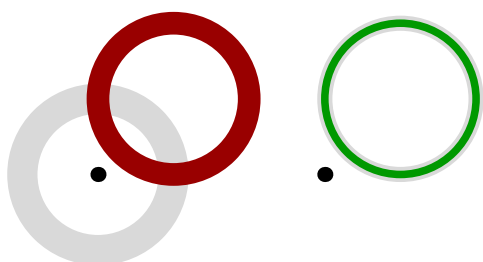

The version of drawdot that we have in LuaMetaFun also handles a path and picture. It actually generates a rather efficient output.

```

\startMPcode
drawdot fullcircle scaled 20mm
  withpen pencircle scaled 2mm withcolor "darkgreen" ;

drawdot image (
  draw fullcircle rotated (45/4) scaled 15mm ;
  draw fullcircle rotated (45/2) scaled 10mm ;
) withpen pencircle scaled 2mm withcolor "darkred" ;
\stopMPcode

```

Looking at the definition of this macro might actually teach you some tricks as it used functionality not present in stock MetaPost.

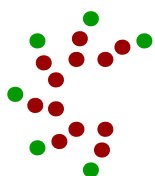

Although MetaPost relates to PostScript its ancestor MetaFont is slightly different when it comes to transform matrices. The following definitions from MetaFun show this:

```

vardef tottransform(expr x, y, xx, xy, yx, yy) =
  save t ; transform t ;
  xpart t = xx ; ypart t = yy ;

```

```

    xypart t = xy ; yypart t = yx ;
    xpart t = x ; yypart t = y ;
    t
enddef ;

vardef bymatrix(expr rx, sx, sy, ry, tx, ty) =
    save t ; transform t ;
    xypart t = rx ; yypart t = ry ;
    xypart t = sx ; yypart t = sy ;
    xpart t = tx ; yypart t = ty ;
    t
enddef ;

```

The second definition can come in handy when you operate in a PostScript, pdf, svg or similar regime.

```

\startMPcode
draw (fullcircle scaled 20mm)
    withpen  pencircle scaled 1mm withcolor "darkred" ;
draw (fullcircle scaled 20mm) transformed bymatrix(2,0.5,0.5,1,5mm,-5mm)
    withpen  pencircle scaled 1mm withcolor "darkblue" ;
\stopMPcode

```

The term transform matrix is often use in this context and it also shows up when fonts are involved. The first and third parameter are scales, the second and third slant and/or rotate, while the last two move.

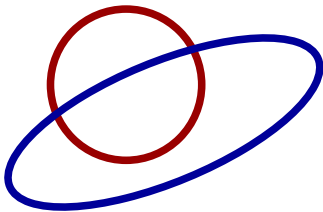

20 Envelopes

20.1 Introduction

Envelopes are what MetaPost makes for a non circular path. A circular path is supported directly by PostScript and pdf. When such a path is rotated, it is still somewhat easy because MetaPost outputs the shape twice, transformed differently, but in the end we have one curve, and filling the right space the two curves bound which is native behavior of path filling. When the pen is more complex, that is not a transformed basic pencircle, MetaPost will calculate a so called envelope. This chapter limits the explanation to what we can observe and better explanations about pens can be found in the MetaFont book.

20.2 Pens

The code involved is non trivial and can only work reliably for paths made from straight lines which is why a pen is always reduced to a path with straight lines. Internally the term 'convex hull' is used. In LuaMetaTeX we have that operation as primitive.

```
\startMPcode  
pen mypen ; mypen := makepen (fullcircle) ;  
draw origin withpen mypen scaled 100 withcolor "darkblue" ;  
\stopMPcode
```

By drawing just one point we see the pen:

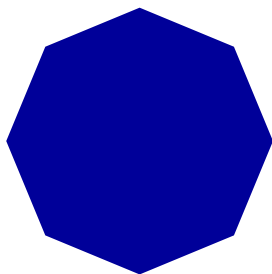

Indeed the circle has been simplified here.

```
\startMPcode  
def ShowPaths(expr pth) =  
  path p[] ;  
  p[0] := pth scaled 50 ;  
  p[1] := uncontrolled p[0] ; % show(p[1]) ;  
  p[2] := convexed p[0] ; % show(p[2]) ;  
  draw p[0] shifted ( 0,0) withpen pencircle scaled 5 withcolor "darkgreen" ;  
  draw p[1] shifted (100,0) withpen pencircle scaled 5 withcolor "darkred" ;  
  draw p[2] shifted (160,0) withpen pencircle scaled 5 withcolor "darkblue" ;  
  draw p[1] shifted (260,0) withpen pencircle scaled 5 withcolor "darkred" ;  
  draw p[2] shifted (260,0) withpen pencircle scaled 5 withcolor "white" ;  
enddef ;  
  
ShowPaths(fullcircle) ;
```

`\stopMPcode`

In this case the straightforward removal of control points gives the same result as first calculating the convex hull.

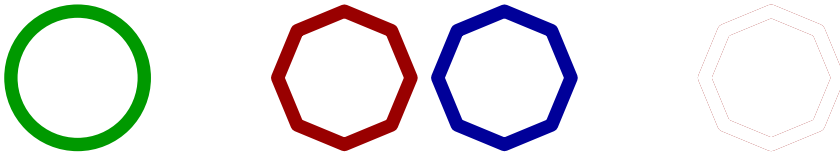

`\startMPcode`

```
ShowPaths(fullcircle randomized .1) ;
```

`\stopMPcode`

In this example we still seem to get what we expect:

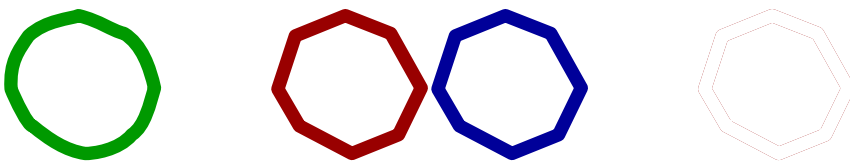

`\startMPcode`

```
ShowPaths(fullcircle randomized .4) ;
```

`\stopMPcode`

But a bit of exaggeration shows that we don't get the same:

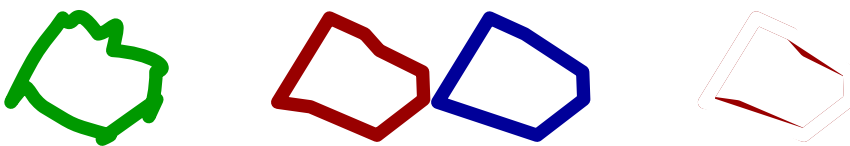

It all has to do with heuristics and nasty border cases when we turn corners. Here is what these (not randomized) paths look like, first the uncontrolled:

```
(25,0) .. controls (22.56,5.89) and (20.12,11.79)
.. (17,68,17,68) .. controls (11.79,20.12) and (5.89,22.56)
.. (0,25) .. controls (-5.89,22.56) and (-11.79,20.12)
.. (-17,68,17,68) .. controls (-20.12,11.79) and (-22.56,5.89)
.. (-25,0) .. controls (-22.56,-5.89) and (-20.12,-11.79)
.. (-17,68,-17,68) .. controls (-11.79,-20.12) and (-5.89,-22.56)
.. (0,-25) .. controls (5.89,-22.56) and (11.79,-20.12)
.. (17,68,-17,68) .. controls (20.12,-11.79) and (22.56,-5.89)
.. cycle
```

and here is the unconvexed:

```
(-25,0) .. controls (-22.56,-5.89) and (-20.12,-11.79)
.. (-17,68,-17,68) .. controls (-11.79,-20.12) and (-5.89,-22.56)
.. (0,-25) .. controls (5.89,-22.56) and (11.79,-20.12)
.. (17,68,-17,68) .. controls (20.12,-11.79) and (22.56,-5.89)
.. (25,0) .. controls (22.56,5.89) and (20.12,11.79)
```

```

.. (17,68,17,68) .. controls (11.79,20.12) and (5.89,22.56)
.. (0,25) .. controls (-5.89,22.56) and (-11.79,20.12)
.. (-17,68,17,68) .. controls (-20.12,11.79) and (-22.56,5.89)
.. cycle

```

Now, in order to see what convexing has to do with pens we also introduce a ‘nep’ which is a pen that doesn’t get its path convexed. We mainly have this variant available for experimenting and documentation purposes. Take these definitions:

```

\startMPdefinitions
path PthP ; PthP := (fullcircle scaled 100) randomized 80 ;
pen PenP ; PenP := makepen PthP ;
nep NepP ; NepP := makenep PthP ;
path ConP ; ConP := convexed PthP ;
path UncP ; UncP := uncontrolled PthP ;
\stopMPdefinitions

```

That are used in:

```

\startMPdefinitions
def Pth =
  draw PthP ;
enddef ;
def Pen =
  draw origin withpen PenP withcolor "darkred" withtransparency (1,.5) ;
enddef ;
def Nep =
  draw origin withpen NepP withcolor "darkblue" withtransparency (1,.5);
enddef ;
def Con =
  fill ConP withpen pencircle scaled 0 withcolor "darkgreen" withtransparency
  (1,.5) ;
enddef ;
def Unc =
  fill UncP withpen pencircle scaled 0 withcolor "darkyellow" withtransparency
  (1,.5) ;
enddef ;
\stopMPdefinitions

```

The main reason for showing the differences in figure 20.1 is that one should be aware of possible side effects

In case you doubt if all this matters, if we use a not to weird path, we’re fine, as is demonstrated in figure 20.2; here we used

```
PthP := fullcircle yscaled 80 xscaled 140 rotated 45 ;
```

And when we use such rather normal (non extreme) paths for pens we’re ready for envelopes.

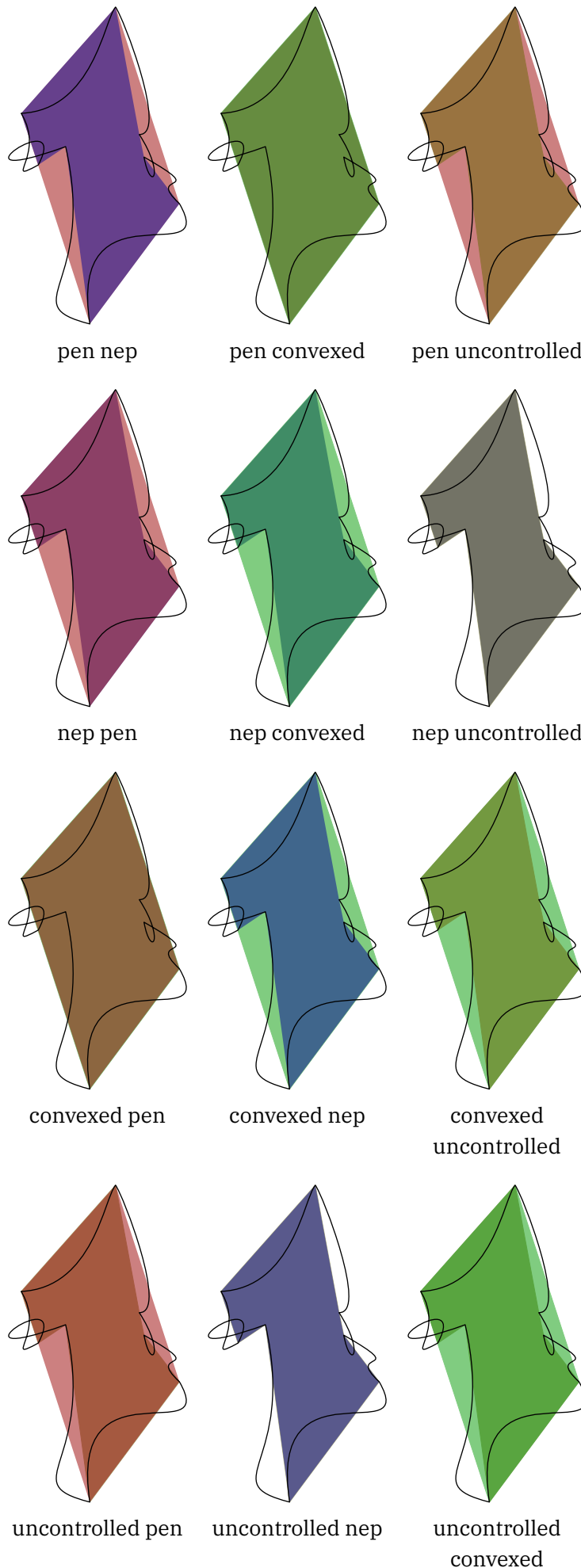

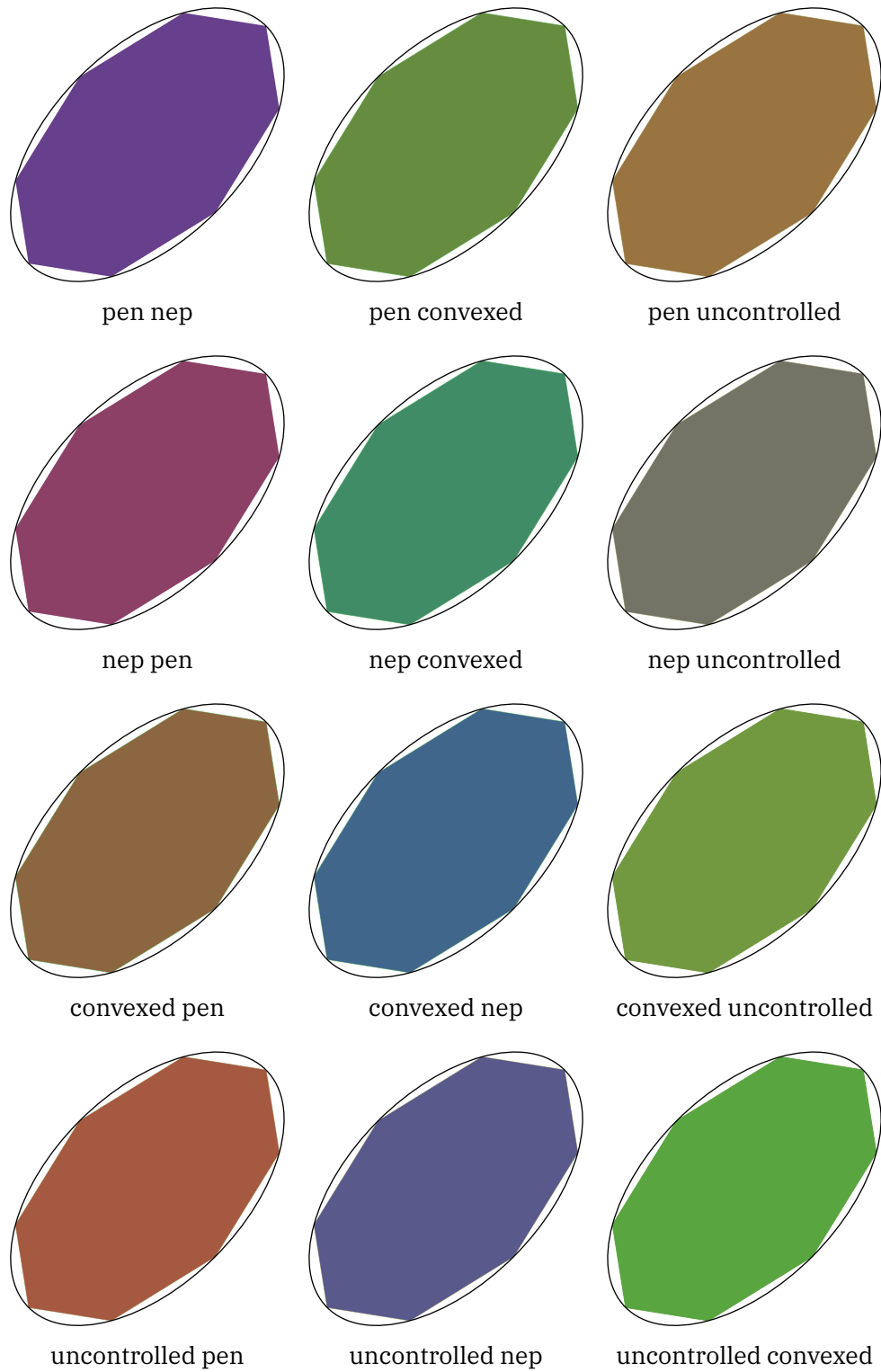

Figure 20.2 When using decent pens the results will be consistent.

20.3 Usage

An envelop is the outline that we get when we run a pen over a path. An envelop is (of course) a closed path. Here is a simple example:

```
\startMPcode
path p ; p := origin -- (100,10) -- cycle ;
path e ; e := envelope pensquare scaled 10 rotated 45 of p ;

draw e withpen pencircle scaled 2 withcolor "darkred" ;
draw p withpen pencircle scaled 2 withcolor "darkgray" ;

fill e shifted (120,0) withcolor "darkred" ;
draw p shifted (120,0) withcolor "lightgray" withpen pencircle scaled 2 ;

fill e shifted (240,0)
  withshademethod "linear"
  withshadecolors ("darkred","lightgray") ;
\stopMPcode
```

This also demonstrates that this way you can apply a shade to a path:



One problem with envelopes is that you can get unexpected results so let's try to explore some details. We start by defining a main path, a pen, a path from the pen, and two envelopes.

```
\startMPcode
path PthP ; PthP := fullcircle xysized(10cm,2cm) ;
pen PenP ; PenP := pensquare scaled 2mm rotated 45 ;
path PthU ; PthU := fullsquare scaled 2mm rotated 45 ;
path PatP ; PatP := makepath PenP ;

path PthI ; PthI := envelope PenP of reverse PthP ;
path PthO ; PthO := envelope PenP of PthP ;

fill PthI && PthO && cycle withcolor "lightgray" ;

draw PthI withcolor "darkred" ;
draw PthO withcolor "darkgreen" ;
draw PthP dashed evenly ;
\stopMPcode
```

Watch the difference between the two envelopes: one is the result from traveling the pen clockwise and one from running anti-clockwise:

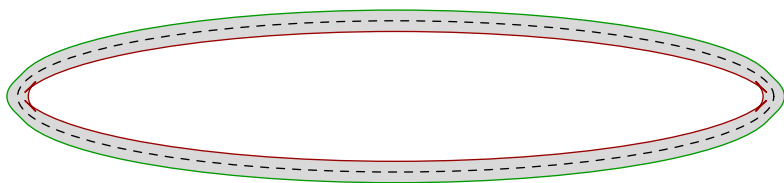

We can emulate running the pen over the path:

```

\startMPcode
fill PthI && PthO && cycle withcolor "darkgray" ;
fill
  for i within (arcpointlist 50 of PthP) :
    PatP shifted pathpoint &&
  endfor cycle
  withcolor "middlegray" ;
\stopMPcode

```

Instead of drawing 50 paths, we draw an efficient single one made from 50 segments and we get this:



If you look closely at the first rendering you will notice an artifact in the inner envelope.

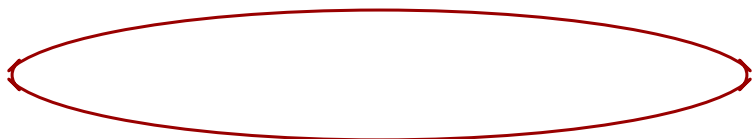

We can get rid of this with a helper macro:

```

\startMPcode
draw reducedenvelope(PthI) withpen pencircle scaled .4mm withcolor "darkred" ;
\stopMPcode

```

Of course you get no guarantees but here it works:



One reason why the helper is not in the core is that it doesn't catch all cases:

```

\startMPcode
path p ; p := fullcircle scaled 4cm ;
pen e ; e := pensquare scaled 3mm ;
draw envelope e of p ;
draw envelope e of reverse p ;
p := p rotated eps shifted (5cm,0) ;
draw envelope e of p ;
draw envelope e of reverse p ;
p := p shifted (5cm,0) ;
draw p enveloped e ;
draw (reverse p) enveloped e ;
\stopMPcode

```

Watch how a tiny rotations rid us of the weird rectangle, and the helper makes three extra inflected points go away but we're still stuck with an imperfection.

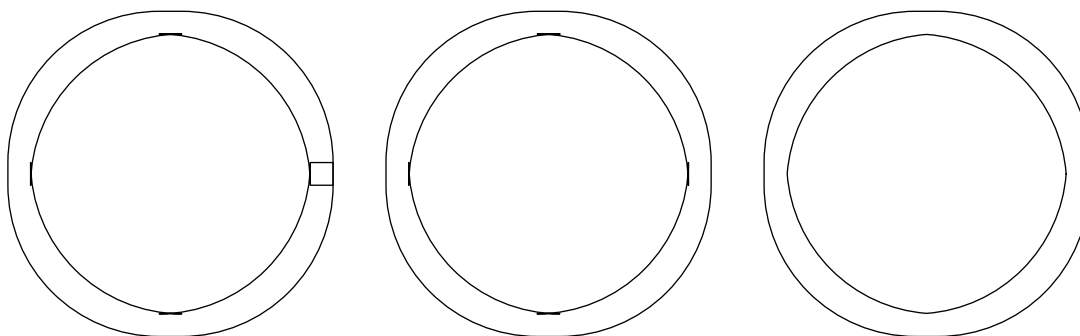

When we only fill the envelope we don't suffer from this because the artifacts stay within the bounds. Sometimes rotating the pen by eps also helps.

```
\startMPcode
path p ; p := fullcircle scaled 4cm ;
pen e ; e := pensquare scaled 3mm ;
fill
  (envelope e of p) && (envelope e of reverse p) && cycle
  withcolor "darkblue" ;
draw % just show the artifacts:
  (envelope e of p) && (envelope e of reverse p) && cycle
  withcolor "white" ;
\stopMPcode
```

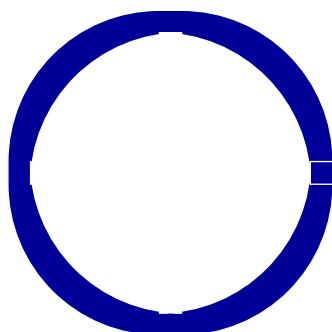

20.4 Details

For those who are interested in seeing what goes on behind the scenes, this section shows some examples that we made when writing an article about envelopes. We start with a couple of definitions

```
\startMPdefinitions
loadmodule("misc") ;

path mypaths[] ;
path mypens[] ;

mypens[ 1 ] := fullcircle scaled 15mm ;
mypens[ 2 ] := fulldiamond scaled 15mm ;
```

```

mypens[ 3 ] := fulltriangle scaled 15mm ;
mypens[ 4 ] := fullsquare scaled 15mm ; % randomized 4mm ;
mypens[ 5 ] := starring(-1/3) scaled 15mm ;
mypens[ 6 ] := starring(-1/2) scaled 15mm ;
mypens[ 7 ] := starring(-eps) scaled 15mm ;
mypens[ 8 ] := starring(1) scaled 15mm ;
mypens[ 9 ] := starring(1/2) scaled 15mm ;
mypens[10] := starring(eps) scaled 15mm ;

mypaths[1] := fullcircle scaled 10cm ;
mypaths[2] := ((0,0) -- (1/2,1/2) -- (2/2,0)) scaled 10cm ;
mypaths[3] := ((0,0) -- (1/2,1/2) -- (2/2,0) -- cycle) scaled 10cm ;
\stopMPdefinitions

```

We are not going to use all these shapes and pens here but you might want to try out some yourself. We Figure 20.3 we apply a so called pensquare to the paths. In Figure 20.4 we use a star but MetaPost will turn this one into a rectangle. In Figure 20.5 we also use star but here the points are used.

```

\startMPcode
draw showenvelope(mypaths[1], mypens[4]) ;
draw showenvelope(mypaths[2], mypens[4]) shifted (10cm, 1cm) ;
draw showenvelope(mypaths[3], mypens[4]) shifted (10cm, -6cm) ;
\stopMPcode

```

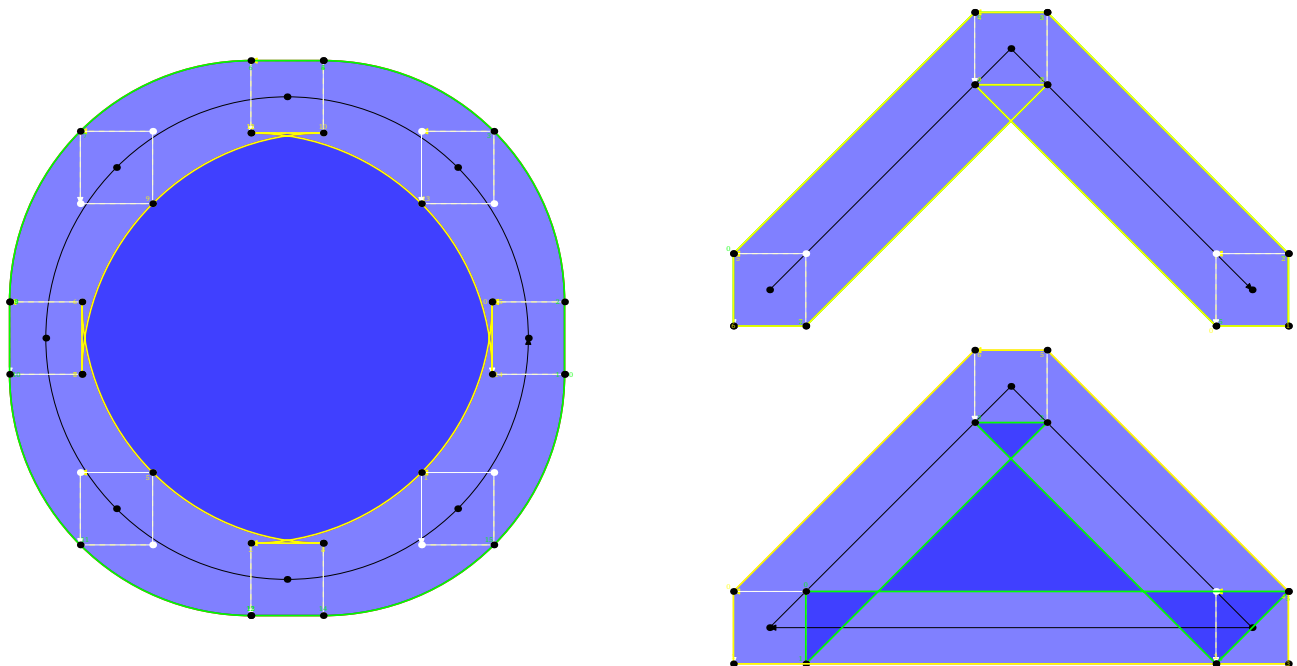

Figure 20.3 How pen 4 creates an envelope.

```

\startMPcode
draw showenvelope(mypaths[1], mypens[6]) ;
draw showenvelope(mypaths[2], mypens[6]) shifted (10cm, 1cm) ;
draw showenvelope(mypaths[3], mypens[6]) shifted (10cm, -6cm) ;
\stopMPcode
\stopMPcode

```

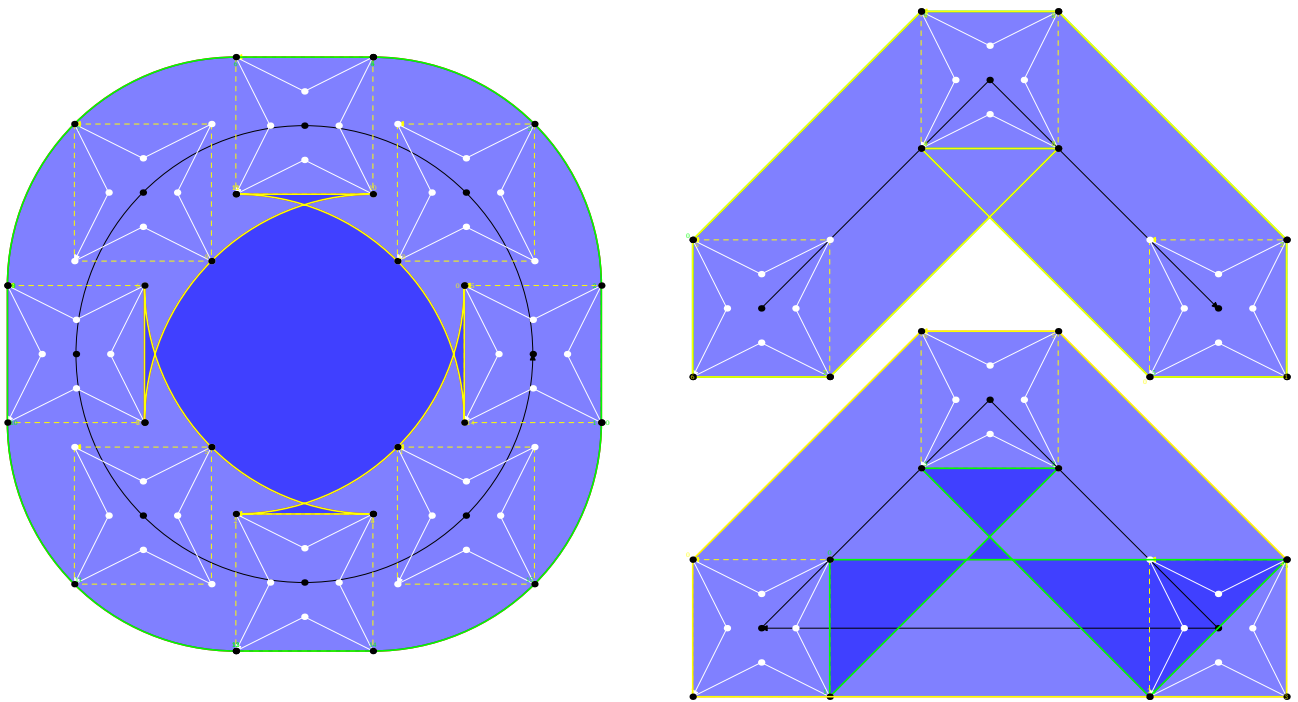

Figure 20.4 How pen 6 creates an envelope.

```

\startMPcode
draw showenvelope(mypaths[1], mypens[9]) ;
draw showenvelope(mypaths[2], mypens[9]) shifted (10cm, 1cm) ;
draw showenvelope(mypaths[3], mypens[9]) shifted (10cm, -6cm) ;
\stopMPcode

```

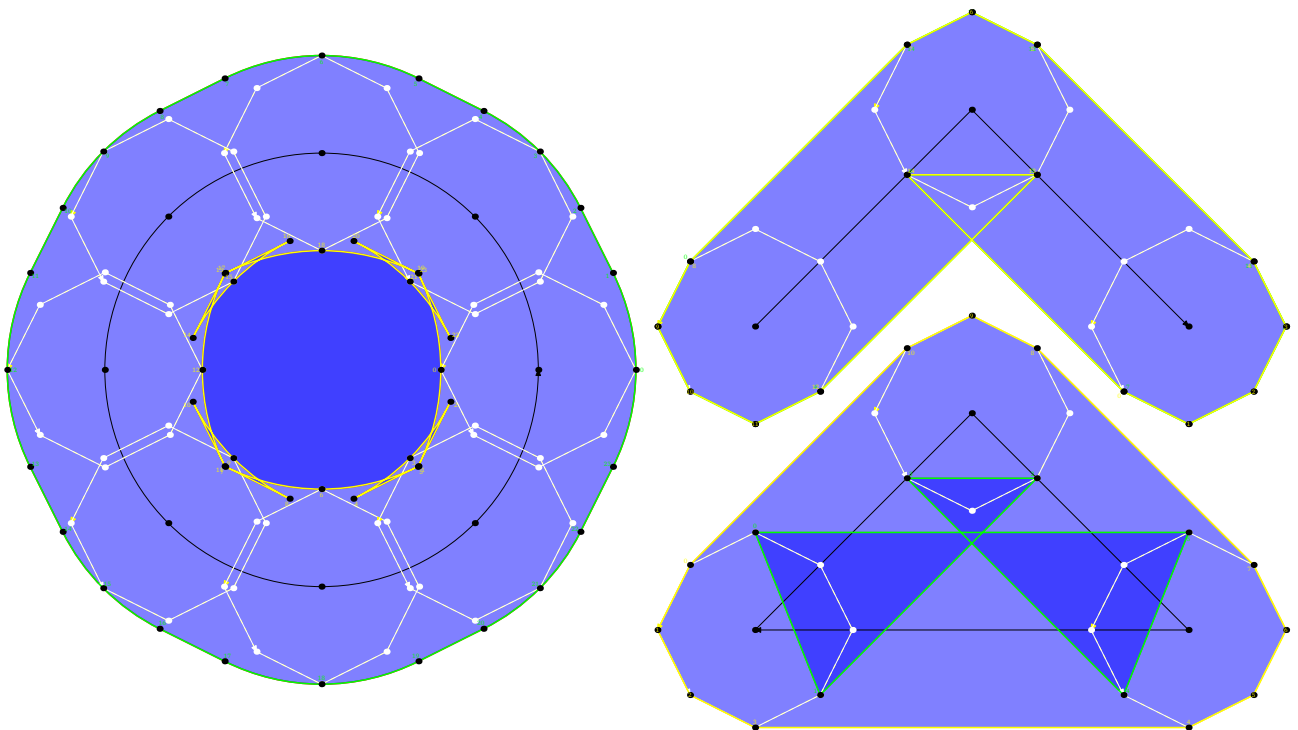

Figure 20.5 How pen 9 creates an envelope.

20.5 Reducing

If you watch the third shape in the previous examples, the last figure differs in that it has a symmetrical inner envelope. We can actually use this knowledge to define a pensquare that is better suited for envelopes. We take this example:

```
\startMPdefinitions
def ExamplePaths =
  path PthA ; PthA := fullcircle scaled 5cm ;
  path PthB ; PthB := triangle scaled 5cm ;

  draw envelope pensquare scaled 10mm of reverse PthA
    withpen pencircle scaled 2mm
    withcolor "darkblue"
  ;
  draw envelope pensquare scaled 10mm of reverse PthB
    withpen pencircle scaled 2mm
    withcolor "darkblue"
  ;

  draw (reverse PthA) enveloped (pensquare scaled 10mm)
    withpen pencircle scaled 2mm
    withcolor "darkred"
  ;
  draw (reverse PthB) enveloped (pensquare scaled 10mm)
    withpen pencircle scaled 2mm
    withcolor "darkred"
  ;
enddef ;
\stopMPdefinitions
```

We define two renderings, one with the normal pensquare definition:

```
\startMPcode
pensquare := makepen(unitsquare shifted -(.5,.5)) ; ExamplePaths ;
\stopMPcode
```

and one with an alternative definition where we have middle points on the edges that stick out one eps:

```
\startMPcode
pensquare := makepen((starring(eps) scaled 1/2)) ; ExamplePaths ;
\stopMPcode
```

This gives figure 20.6. The blue extensions are what we get without clean up but at least the alternative has symmetrical ears.

When you have a somewhat weird envelope the `reducedenvelope` macro might be able to improve it. The `<pth> enveloped <pen>` primary macro has this built in.

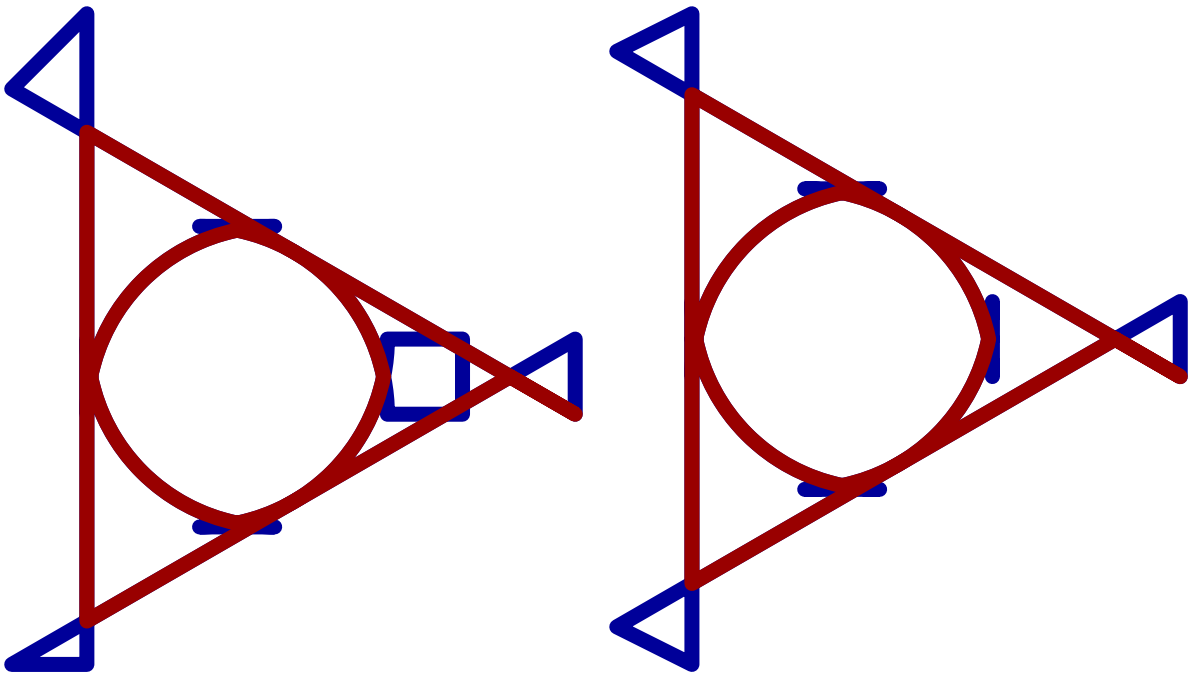

default pensquare

alternative pensquare

Figure 20.6 An alternative pensquare.

21 Groups

This is just a quick example of an experimental features.

```
\startMPcode
  fill fullcircle scaled 2cm shifted ( 5mm,2cm) withcolor "darkblue" ;
  fill fullcircle scaled 2cm shifted (15mm,2cm) withcolor "darkblue" ;

  fill fullcircle scaled 2cm shifted ( 5mm,-2cm) withcolor "darkgreen" ;
  fill fullcircle scaled 2cm shifted (15mm,-2cm) withcolor "darkgreen" ;

  draw image (
    fill fullcircle scaled 4cm withcolor "darkred" ;
    fill fullcircle scaled 4cm shifted (2cm,0) withcolor "darkred" ;

    setgroup currentpicture to boundingbox currentpicture
      withtransparency (1,.5) ;
  ) ;

  draw image (
    fill fullcircle scaled 3cm withcolor "darkyellow"
      withtransparency (1,.5) ;
    fill fullcircle scaled 3cm shifted (2cm,0) withcolor "darkyellow"
      withtransparency (1,.5) ;
  ) ;

  addbackground withcolor "darkgray" ;
\stopMPcode
```

A group create an object that when transparency is applied is treated as a group.

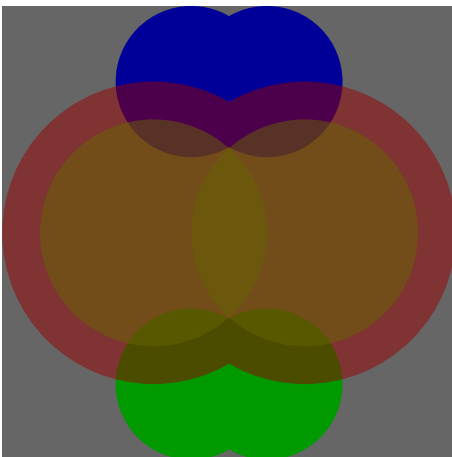

(Groups might become more powerful in the future, like reusable components but then some more juggling is needed.)

22 Potrace

22.1 Introduction

The potrace connection targets at bitmaps. You can think of logos that only exist as bitmaps while outlines are preferred, but in this case we actually think more of bitmaps that the user lays out. In order to give an impression what we are talking about I give three simple examples:

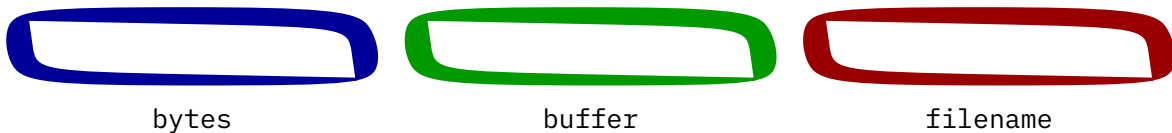

Here we vectorize bitmaps with Peter Selingers potrace library, that we built in LuaMetaTeX. We can directly feed bytes in a MetaFun blob:

```
\startMPcode
  fill
    lmt_potraced [ bytes =
      "011111111111111111111111111111111111100
      110000000000000000000000000000000000110
      110000000000000000000000000000000000011
      110000000000000000000000000000000000011
      110000000000000000000000000000000000011
      011000000000000000000000000000000000011
      001111111111111111111111111111111111110",
    ] ysize 1cm
    withcolor "darkblue"
    withpen pencircle scaled 1 ;
\stopMPcode
```

But we can also go via a file that has the same data:

```
\startMPcode
  fill
    lmt_potraced [
      filename = "potraced.txt",
    ] ysize 1cm
    withcolor "darkgreen"
    withpen pencircle scaled 1 ;
\stopMPcode
```

Of course we can also use buffers:

```
\startMPcode
  fill
    lmt_potraced [
      buffer = "potraced",
    ] ysize 1cm
```

```

withcolor "darkred"
withpen pencircle scaled 1 ;
\stopMPcode

```

You feed a bitmap specification and get back a MetaPost path, likely multiple subpaths sewed together. You can of course draw and fill that path, or store it in a path variable and then do both.

In the following sections we will explore the various options and some tricks. The main message in this section is that you need to look at bitmaps with vectorized eyes because that is what you get in the end: a vector representation.

22.2 Functions

todo

22.3 Icons

When Mikael Sundqvist and I were playing with potrace in MetaFun his girls came up with this pattern.

```

\startMPcode
fill
  lmt_potraced [ bytes =
    "001111100
    010000010
    100000001
    101101101
    100000001
    101000101
    100111001
    010000010
    001111100",
    size = 1,
  ] xysized (3cm,3cm)
  withcolor "middleorange" ;
\stopMPcode

```

This produces the following icon. The somewhat asymmetrical shape gives it a charm, and it is surprising how little code is needed. This picture inspired Willi Egger to make a ten by ten composition gadget for the attendants of the 2023 ConT_EXt meeting that was used in a tutorial.



We use this to demonstrate a few more features of the interface:

```

\startMPcode
draw
  lmt_potraced [ bytes =
    "..11111.."
    ".1.....1."
    "1.....1"
    "1.11.11.1"
    "1.....1"
    "1.1...1.1"
    "1..111..1"
    ".1.....1."
    "..11111.." ,
    polygon = true,
    size = 1,
  ] xysized (3cm,3cm)
  withcolor "darkblue"
  withpen pencircle scaled 1mm ;
\stopMPcode

```

This contour is actually accurate:

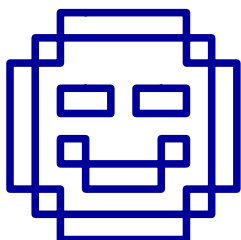

We can color some components:

```

\startMPcode
draw image (
  lmt_startpotraced [ bytes =
    "..11111.."
    ".1.....1."
    "1.....1"
    "1.22.22.1"
    "1.....1"
    "1.3...3.1"
    "1..333..1"
    ".1.....1."
    "..11111.."
  ] ;
  fill lmt_potraced [ value = "1", size = 1 ]
    withcolor "darkred" ;
  fill lmt_potraced [ value = "3", size = 1 ]
    withcolor "darkgreen" ;
  fill lmt_potraced [ value = "2", size = 0 ]
    withcolor "darkblue" ;

```

```

    lmt_stoppotraced ;
) xysized (3cm,3cm) ;
\stopMPcode

```

Of course there must be enough distinction (white space) between the shapes:

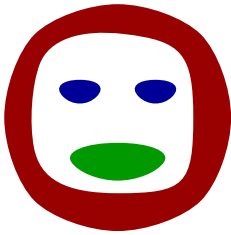

Again we show the polygons:

```

\startMPcode
draw image (
  lmt_startpotraced [ bytes =
    ..11111..
    .1.....1.
    1.....1
    1.22.22.1
    1.....1
    1.3...3.1
    1..333..1
    .1.....1.
    ..11111..
  ] ;
  draw lmt_potraced [ value = "1", size = 1, polygon = true ]
    withcolor "darkred" ;
  draw lmt_potraced [ value = "3", size = 1, polygon = true ]
    withcolor "darkgreen" ;
  draw lmt_potraced [ value = "2", size = 0, polygon = true ]
    withcolor "darkblue" ;
  lmt_stoppotraced ;
)
  xysized (3cm,3cm)
  withpen pencircle scaled 1mm ;
\stopMPcode

```

Gives:

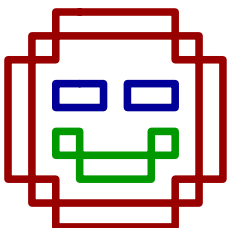

We can do the same with data defined in Lua:

```

\startluacode
io.savedata("temp.txt",[[
..11111..
.1.....1.
1.....1
1.22.22.1
1.....1
1.3...3.1
1..333..1
.1.....1.
..11111..
]])
\stopluacode

```

With:

```

\startMPcode
draw image (
  lmt_startpotraced [ filename = "temp.txt" ] ;
  fill lmt_potraced [ value = "1", size = 1 ]
    withcolor "darkcyan" ;
  fill lmt_potraced [ value = "3", size = 1 ]
    withcolor "darkmagenta" ;
  fill lmt_potraced [ value = "2", size = 0 ]
    withcolor "darkyellow" ;
  lmt_stoppotraced ;
) xysized (3cm,3cm) ;
\stopMPcode

```

Indeed we get:



22.4 Fonts

maybe

22.5 Contour type graphics

By combining some Lua with potrace we can do contour graphics. There is currently no interface for this; we give one example. Say that we want to plot the solutions to the equation

$$xy^2 + 2x^3y^3 - y - 1 = 0$$

for $-5 \leq x \leq 5$ and $-5 \leq y \leq 5$. We can then do

```
\startluacode
  local N = 2000
  local xmin = -5
  local ymin = -5
  local xmax = 5
  local ymax = 5
  local xstep = (xmax - xmin)/N
  local ystep = (ymax - ymin)/N

  local function f(x,y)
    local x = xmin + xstep*x
    local y = ymin + ystep*y
    local z = x*y^2 + 2*x^3*y^3 - y - 1
    if z > 0 then
      return '1'
    else
      return '0'
    end
  end
end

  potrace.setbitmap("mybitmap", potrace.contourplot(N,N,f))
\stopluacode
```

Then we can make a graphic with

```
\startMPcode
  numeric N ; N := 2000 ;
  path p ; p := lmt_potraced [
    stringname = "mybitmap",
    value      = "1",
    tolerance  = 0.001,
    threshold  = 1,
    optimize   = true,
  ] ;
  p := p shifted (-N/2,-N/2) ;
  message(boundingBox p) ;
  p := p xsize 10cm ;
  draw p withpen pencircle scaled 1 withcolor "darkblue" ;
  drawpoints p withcolor "orange" ;
  drawpointlabels p ;
\stopMPcode
```

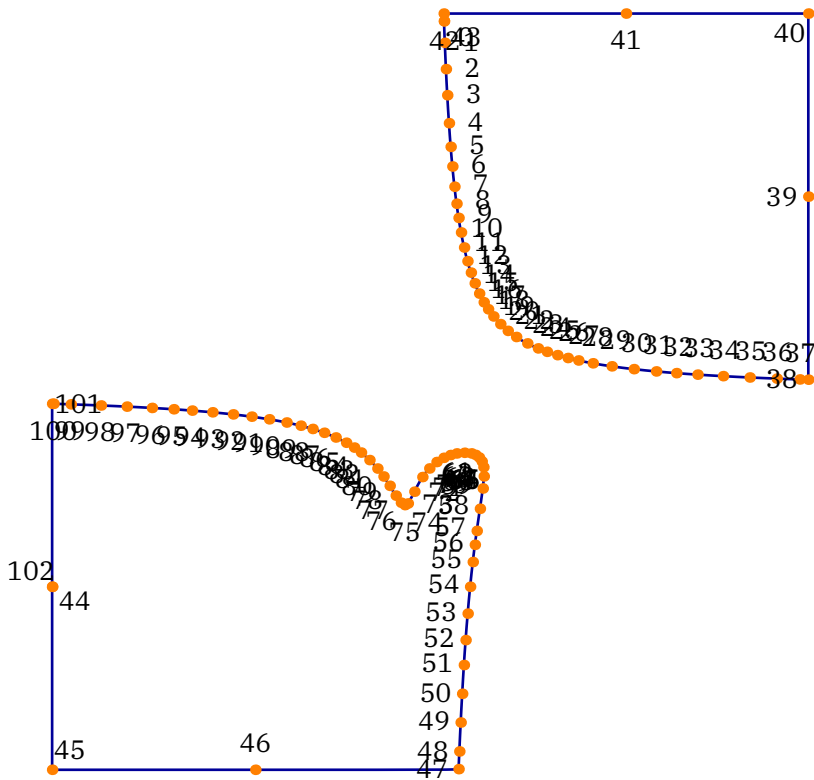

By looking at the result we see that we want the subpaths from point 42 to 43 (yes, it is sometimes a bit curious on where potrace starts and stops), 0 to 38, and 47 to 101. Now we can instead do

```

\startMPcode
  numeric N ; N := 2000 ;
  path p ; p := lmt_potraced [
    stringname = "mybitmap",
    value       = "1",
    tolerance   = 0.001,
    threshold   = 1,
    optimize    = true,
  ] ;
  p := p shifted (-N/2,-N/2) ;
  message(boundingBox p) ;
  p := p xsize 10cm ;
  fill p withcolor 0.75[darkred,white] ;
  p := subpath(42,43) of p && subpath(0,38) of p && subpath(47,101) of p ;
  draw p withpen pencircle scaled 1 ;
  drawarrow (0,-5cm) -- (0,5cm) ;
  drawarrow (-5cm,0) -- (5cm,0) ;
\stopMPcode

```

to get

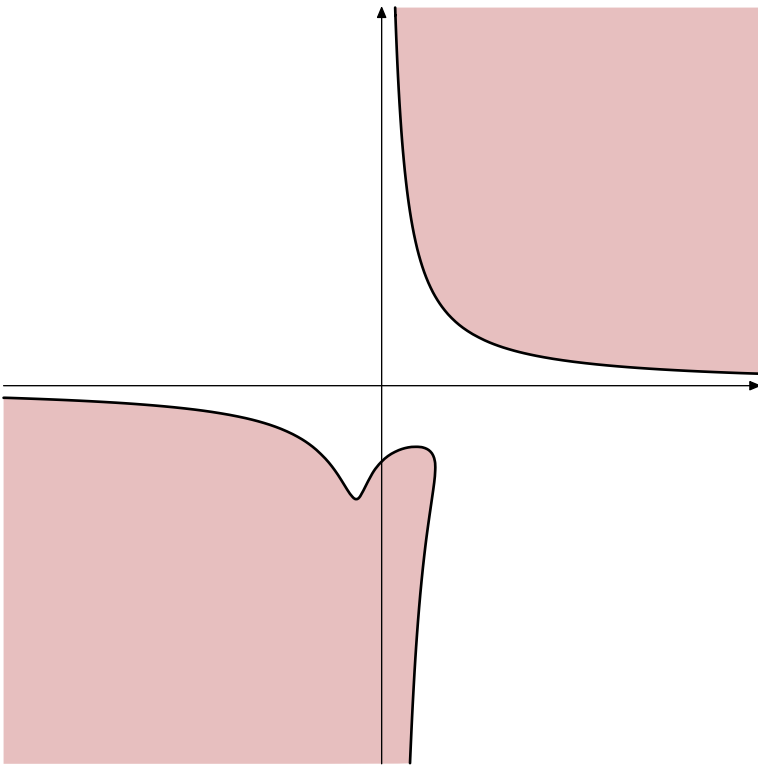

23 Extensions

23.1 Introduction

This is an uncorrected preliminary chapter.

The T_EX and MetaPost macro languages each have their characteristics and as a result the Lua interfaces in both these subsystems are different. There are however some similarities in fetching from, scanning, and pushing back into these subsystems and by using wrappers the nasty details get hidden from users. Wrapping also permits these interfaces to evolve to a stable state.

In due time much will be documented but currently a lot is also a bit experimental because that is the way I can converge to what works best. You can assume that the solutions in the `mplib-*.lmt` files in some form stay (unless it looks too weird). Just stick to the abstractions and you will be fine.

The functionality described here is available in LMTX. Although some prototypes can be found in MkIV you should not expect the same behavior there.

23.2 The LUA interface (strings)

23.2.1 Strings

At some point the `runscript` primitive was added to `mplib`. Because officially the library is not bound to Lua this neutral name was chosen. In `LuaMetaTEX` we have a follow up on that library and although it's still neutral we just assume that Lua is used. The `MetaFun` follow up is therefore called `LuaMetaFun`, and it used the new interfaces to implement efficient going back and forth between T_EX, MetaPost and Lua.

The `runscript` macro is used like this:

```
\startMPcode
draw
  textext("This will print \quotation{Hi} in the console!")
  xsized TextWidth
  withcolor "darkblue" ;
runscript("print('Hi')");
\stopMPcode
```

This will print “Hi” in the console!

The `runscript` primitive triggers a callback that gets the string passed. This callback then does some magic, normally compiling that string into byte code and execute it. The compiled function can return a string that is then fed back into the MetaPost `scantokens` primitive command. So, that return value has to be valid MetaPost!

```
\startMPcode
```

```

string s ;
s := runscript("mp.quoted('This will return a string!')") ;
draw texttext(s)
    xsized TextWidth
    withcolor "darkgreen" ;
\stopMPcode

```

This will return a string!

The `mp.quoted` call is one of the build into ConT_EXt ways to pipe back something to MetaPost. We will cover this later. If you don't want to use that feature, the call would have looked like this:

```

\startMPcode
string s ;
s := runscript("return " &
    "'" & ditto &
    "Ditto is a string that contains a double quote!"
    & ditto & "'")
) ;
draw texttext(s)
    xsized TextWidth
    withcolor "darkred" ;
\stopMPcode

```

Ditto is a string that contains a double quote!

The `ditto` with ampersands trickery constructs a string with embedded quotes which is needed because you want to pass back a string and MetaPost only considers something a string when it sees double quotes.

23.2.2 Numerics

Instead of a string you can also pass a numeric:

```

\startMPcode
runscript 10000;
\stopMPcode

```

This time, on the console you will see something:

```

metapost > lua > 1: bad index: 10000
metapost > lua > 1: no result, invalid code: 10000

```

This I because at the Lua end this number should result in some action, in the case of ConT_EXt calling a registered function. Because the given number is unknown nothing is done. These messages come from ConT_EXt, and MetaPost will keep silent because we don't pass anything back.

This numeric interface only makes sense when the callback handles it and the way ConT_EXt does that is probably unique to that macro package. You can of course create MetaPost instances yourself (in Lua) and handle callbacks your own way: you get a string, do this, you get a number, do that.

23.2.3 Helpers

In order to help users passing data to the Lua end there are some helper macros defined using the lua macro with suffixes:

```
draw lua.mp.foo(0,2,(3,4)) ;
fill lua.MP.foo(0,2,(3,4)) ;
```

The lowercase mp namespace is for ConT_EXt itself so if you use that for your own extensions, there is no guarantee against future clashes. The uppercase MP namespace is for users. In any case you need to be aware of expansion, so foo should not expand to something weird (variable names and vardef macro names are okay).

At the Lua end these are mapped onto functions, like:

```
function mp.foo(n,m,p)
  -- do something
end
function MP.foo(n,m,p)
  -- do something
end
```

23.3 Printing back

In the previous chapter we saw mp.quoted being used to print back a string to MetaPost for processing by scantokens. Not all function in the mp namespace are meant for usage, so best stick to what is described here.

The most generic print is mp.print that takes multiple arguments. A numeric value is flushed as serialized number and a string is passed along (so no quotes are added). A boolean becomes true or false. A table with six elements is seen as a transform and otherwise passed as pair, color or cmyk color definition. The print command takes multiple arguments and the results are concatenated into one string with other prints so far.

Because this mechanism is already available in MkIV we remain compatible which means that the print functions are available in the mp namespace but also in the mp.aux namespace. In the meantime we moved to the print namespace. The main print command does a guess about what it is fed and will inject that as string. Thereby the next are all valid:

```
fill fullcircle scaled runscript("mp.print      ('3cm')") withcolor "darkred" ;
fill fullcircle scaled runscript("mp.print.print('2cm')") withcolor "darkgreen" ;
fill fullcircle scaled runscript("mp.aux.print  ('1cm')") withcolor "darkblue" ;
```

string	string	passed as it is but with percent, double quote and newline escaped
boolean	boolean	the true or false primitives

<code>integer</code>	<code>number</code>	an integer
<code>number</code>	<code>number</code>	a float
<code>numeric</code>	<code>number</code>	a float (same as previous)
<code>points</code>	<code>number</code>	a scaled numeric with pt unit
<code>pair</code>	<code>numbers or table</code>	a pair (x,y) or (x,x)
<code>pairpoints</code>	<code>numbers or table</code>	idem but with scaled numbers and a pt unit
<code>triplet</code>	<code>numbers or table</code>	a rgb triplet (r,g,b)
<code>tripletpoints</code>	<code>numbers or table</code>	idem but with scaled numbers and a pt unit
<code>quadruple</code>	<code>numbers or table</code>	a cmyk quadruple (c,m,y,k)
<code>quadruplepoints</code>	<code>numbers or table</code>	idem but with scaled numbers and a pt unit
<code>color</code>	<code>numbers or table</code>	a numeric, triplet or quadruple
<code>transform</code>	<code>numbers or table</code>	a six element transform
<code>print</code>	<code>whatever</code>	the normal semi-intelligent printer
<code>fprint</code>	<code>format, whatever</code>	the normal semi-intelligent printer using a format
<code>vprint</code>	<code>variable</code>	the normal semi-intelligent printer with escaped percents, quotes and newlines
<code>quoted</code>	<code>string</code>	a valid string surrounded by quotes with an optional first format specifier

A more complex printer is `path` that takes upto three arguments. The first argument is a table. Entries have two or six elements where the last two are control points. The second argument indicates the connector: `true` and `nil` indicate `..` while `false` will use `--`. When the last argument is `true` we have a closed path. Alternatively the table can have a boolean `cycle` field. So these are all valid:

```
local t1 = { {0,0}, {1,0}, {1,1}, {0,1} }
local t2 = { {0,0}, {1,0}, {1,1}, {0,1}, cycle = true }
```

```
mp.print.path(t1)
mp.print.path(t1,nil,true)
mp.print.path(t1,true,true)
mp.print.path(t1,false)
mp.print.path(t1,false,true)
mp.print.path(ts,false)
mp.print.path(t1,"...",true)
mp.print.path(t1,"..",true)
mp.print.path(t2,"..")
```

As with the already mentioned simple printers there is a variant that scales: `pathpoints` (an alternative is of course to scale the whole path by pt).

The result of what goes into the print functions is collected and flushed to MetaPost at the end of a call. You can directly push something in the buffer with `mp.direct` and condense the (so far) buffered content with `mp.flush`. Normally you will not need such low level handling.

23.4 Direct values

The print functions accumulate and flush at the end. Alternatively you can return a value. In that case the type determines what gets done:

```
number    native quantity
boolean   native quantity (I need to check this!)
string    feeds into scantokens
table     feeds concatenated into scantokens
```

Instead of return you can also call an injector. The repertoire is similar to the printers: boolean, cmykcolor, color, integer, number, numeric, pair, path, quadruplet, string, transform, triplet and whatever (kind of automatic):

```
function MP.MyFunction()
  mp.inject.string("This is just a string.")
end
```

The whd, xy and pt injectors inject triplets, pairs and numeric scaled from T_EX scaled points to base points.

23.5 Registering

Quite some of the build in functionality uses a slightly different approach. It roughly works as follows:

```
% reserve an index and set its value:
```

```
newscripindex user_me_foo ; user_me_foo := scripindex "user_me_foo" ;
```

```
% wrap the call into a macro:
```

```
def me_foo = runscript user_me_foo enddef ;
```

A macro can of course be more complex, for instance take arguments and push those into the script call:

```
def me_foo(expr a, b) = runscript user_me_foo a b enddef ;
```

But before this is done at the MetaPost end, you need to define the Lua function:

```
local function user_me_foo()
  -- do something useful
end
```

```
metapost.registerscript("user_me_foo",user_me_foo)
```

In this case you use the print and inject functions, of course only when you want to push back some result.

Alternatively you can do:

```
metapost.registerdirect("user_me_foo",user_me_foo)
metapost.registertokens("user_me_foo",user_me_foo)
```

A direct script will treat return values as native, so string and tables are like quoted string and interpreted objects (boolean, numeric, tables). The tokens variant will feed the strings and concatenated tables into scantokens.

The script index can be fetched at the Lua end with:

```
local index = metapost.scriptindex(name)
```

23.6 Codes and such

Using the to be discussed scanners assumes that you know some of the internals (or at least concepts) of MetaPost. Taco has written some excellent tutorials on the way MetaPost handles input. Here we just mention what you can run into.

Each primitive, macro or variable falls into a category. The primitives are grouped in a way that permits handling them as category and the following table shows the grouping. Internally the subcategories are called modes. You should treat these numbers as abstractions because they can change over time, depending on how the library evolves. Modes can normally be ignored.

code	mode	name	code category
66	1	#@	macrospecial
53	147	&	ampersand
53	148	&&	ampersand
53	149	&&&	ampersand
53	150	&&&&	ampersand
60	130	*	secondarybinary
47	128	+	plusorminus
49	133	++	tertiarybinary
49	134	+++	tertiarybinary
80	0	,	comma
47	129	-	plusorminus
51	0	..	pathjoin
59	131	/	slash
79	0	:	colon
78	0	:=	assignment
81	0	;	semicolon
55	141	<	primarybinary
55	142	<=	primarybinary
55	146	<>	primarybinary
56	145	=	equals
55	143	>	primarybinary
55	144	>=	primarybinary
66	2	@	macrospecial
66	3	@#	macrospecial
37	64	ASCII	unary
68	0	[leftbracket
9	0	\	relax
69	0]	rightbracket
60	132	^	secondarybinary
22	0	addto	addto
72	2	also	thingstoadd
57	140	and	and
37	113	angle	unary
37	112	arclength	unary

41	197	arcpoint	ofbinary
41	198	arcpointlist	ofbinary
41	196	arctime	ofbinary
64	0	atleast	atleast
27	1	batchmode	mode
35	0	begingroup	begingroup
37	19	blackpart	unary
37	15	bluepart	unary
33	23	boolean	typename
37	127	bounded	unary
41	202	boundingpath	ofbinary
1	0	btex	btex
41	204	bytefound	ofbinary
41	206	bytemapbounds	ofbinary
60	162	bytemapscaled	secondarybinary
41	205	bytepath	ofbinary
41	203	bytevalue	ofbinary
37	102	centerof	unary
37	103	centerofmass	unary
37	65	char	unary
44	22	charcode	internal
44	25	chardp	internal
44	24	charht	internal
44	26	charic	internal
44	23	charwd	internal
23	38	clip	setbounds
19	5	clipbytemap	newbytemap
37	125	clipped	unary
37	48	closefrom	unary
33	31	cmykcolor	typename
33	30	color	typename
37	81	colormodel	unary
72	1	contour	thingstoadd
62	0	controls	controls
37	60	convexed	unary
19	2	copybytemap	newbytemap
37	101	corners	unary
37	93	cosd	unary
65	0	curl	curl
37	16	cyanpart	unary
40	114	cycle	cycle
71	1	dashed	with
37	84	dashpart	unary
20	1	def	macrodef
44	36	defaultzeroangle	internal
31	0	delimiters	delimiters
37	111	deltaarclength	unary
37	109	deltadirection	unary

37	106	deltapoint	unary
37	108	deltapostcontrol	unary
37	107	deltaprecontrol	unary
37	110	deltaunitdirection	unary
41	174	direction	ofbinary
41	170	directiontime	ofbinary
72	0	doublepath	thingstoadd
4	3	else	fiorelse
4	4	elseif	fiorelse
20	0	enddef	macrodef
6	0	endfor	iteration
82	0	endgroup	endgroup
5	1	endinput	input
41	201	envelope	ofbinary
29	2	errhelp	message
29	1	errmessage	message
27	4	errorstopmode	mode
2	0	etex	etex
30	0	everyjob	everyjob
8	0	exitif	exittest
13	0	expandafter	expandafter
61	8	expr	parametertype
36	41	false	nullary
4	2	fi	fiorelse
37	123	filled	unary
62	1	firstcontrol	controls
37	72	firstdirection	unary
37	69	firstpoint	unary
37	71	firstpostcontrol	unary
37	70	firstprecontrol	unary
37	73	firstunitdirection	unary
37	94	floor	unary
6	2	for	iteration
6	1	forever	iteration
6	3	forsuffixes	iteration
37	14	greenpart	unary
37	20	greypart	unary
37	126	grouped	unary
37	63	hex	unary
3	1	if	if
58	0	infont	primarydef
24	0	inner	protection
5	0	input	input
16	0	interim	interim
44	41	intersectionprecision	internal
49	164	intersectiontimes	tertiarybinary
49	165	intersectiontimeslist	tertiarybinary
44	3	jobname	internal

44	42	jointolerance	internal
37	50	known	unary
49	136	knowncrossprod	tertiarybinary
49	137	knowndiv	tertiarybinary
49	135	knowndotprod	tertiarybinary
49	138	knownmod	tertiarybinary
37	89	knownnorm	unary
37	95	knownnormalize	unary
37	77	lastdirection	unary
37	74	lastpoint	unary
37	76	lastpostcontrol	unary
37	75	lastprecontrol	unary
37	78	lastunitdirection	unary
36	177	lastx	nullary
36	176	lastxy	nullary
36	178	lasty	nullary
37	67	length	unary
44	40	lessdigits	internal
17	0	let	let
44	32	linecap	internal
44	31	linejoin	internal
37	97	llcorner	unary
37	98	lrcorner	unary
37	17	magentapart	unary
37	59	makenep	unary
37	57	makepath	unary
37	58	makepen	unary
12	0	maketext	maketext
28	1	maxknotpool	onlyset
37	90	mexp	unary
44	34	miterlimit	internal
37	91	mlog	unary
36	200	mpversion	nullary
33	26	nep	typename
19	3	newbytemap	newbytemap
18	0	newinternal	newinternal
40	116	nocycle	cycle
37	68	nolength	unary
27	2	nonstopmode	mode
36	46	normaldeviate	nullary
37	52	not	unary
36	43	nullpen	nullary
36	42	nullpicture	nullary
44	2	numberprecision	internal
44	1	numbersystem	internal
33	33	numeric	typename
37	62	oct	unary
37	49	odd	unary

73	0	of	of
49	139	or	tertiarybinary
24	1	outer	protection
44	30	overloadmode	internal
33	32	pair	typename
33	27	path	typename
36	185	pathdirection	nullary
36	191	pathfirst	nullary
36	188	pathindex	nullary
36	192	pathlast	nullary
36	189	pathlastindex	nullary
36	190	pathlength	nullary
37	82	pathpart	unary
36	182	pathpoint	nullary
36	184	pathpostcontrol	nullary
36	183	pathprecontrol	nullary
36	187	pathstate	nullary
36	186	pathunitdirection	nullary
36	193	pathxpart	nullary
36	194	pathypart	nullary
44	27	pausing	internal
33	25	pen	typename
36	45	pencircle	nullary
41	195	penoffset	ofbinary
37	83	penpart	unary
33	28	picture	typename
41	171	point	ofbinary
41	173	postcontrol	ofbinary
37	86	postscriptpart	unary
41	172	precontrol	ofbinary
37	85	prescriptpart	unary
36	180	previousx	nullary
36	179	previousxy	nullary
36	181	previousy	nullary
61	1	primary	parametertype
20	3	primarydef	macrodef
44	44	pruneoptions	internal
37	79	prunesingularities	unary
28	0	randomseed	onlyset
37	47	readfrom	unary
36	44	readstring	nullary
40	115	recycle	cycle
37	13	redpart	unary
19	6	reducebytemap	newbytemap
19	8	resetbytemap	newbytemap
19	9	resetbytemaps	newbytemap
44	39	restoreclipcolor	internal
37	54	reverse	unary

33	30	rgbcolor	typename
60	151	rotated	secondarybinary
11	0	runscript	runscript
15	0	save	save
60	153	scaled	secondarybinary
10	0	scantokens	scantokens
27	3	scrollmode	mode
61	2	secondary	parametertype
20	4	secondarydef	macrodef
62	2	secondcontrol	controls
41	169	segment	ofbinary
37	66	segments	unary
23	40	setbounds	setbounds
19	0	setbyte	newbytemap
19	4	setbytemap	newbytemap
19	1	setbytemapoffset	newbytemap
19	7	setbytemapoptions	newbytemap
23	39	setgroup	setbounds
25	1	setproperty	property
60	154	shifted	secondarybinary
21	0	shipout	shipout
26	2	show	show
26	4	showdependencies	show
26	1	showstats	show
44	28	showstopping	internal
26	0	showtoken	show
26	3	showvariable	show
27	5	silentmode	mode
37	92	sind	unary
44	43	singlequotemode	internal
37	56	singularity	unary
60	152	slanted	secondarybinary
37	88	sqrt	unary
44	33	stacking	internal
37	87	stackingpart	unary
75	0	step	step
38	0	str	str
33	24	string	typename
37	124	stroked	unary
41	199	subarclength	ofbinary
41	168	subpath	ofbinary
41	167	substring	ofbinary
61	9	suffix	parametertype
63	0	tension	tension
61	3	tertiary	parametertype
20	5	tertiarydef	macrodef
44	29	texscriptmode	internal
61	10	text	parametertype

44	19	time	internal
74	0	to	to
44	6	tracingcapsules	internal
44	8	tracingchoices	internal
44	10	tracingcommands	internal
44	7	tracingdependencies	internal
44	5	tracingequations	internal
44	12	tracingmacros	internal
44	15	tracingonline	internal
44	13	tracingoutput	internal
44	11	tracingrestores	internal
44	9	tracingspecs	internal
44	14	tracingstats	internal
44	4	tracingtitles	internal
33	29	transform	typename
60	155	transformed	secondarybinary
36	40	true	nullary
44	37	truecorners	internal
37	80	turningnumber	unary
37	99	ulcorner	unary
37	61	uncontrolled	unary
37	55	uncycle	unary
37	96	uniformdeviate	unary
41	175	unitdirection	ofbinary
37	51	unknown	unary
76	0	until	until
37	100	urcorner	unary
20	2	vardef	macrodef
1	1	verbatimtex	btex
39	0	void	void
44	35	warningcheck	internal
71	17	withbytemap	with
71	11	withmykcolor	with
71	15	withcurvature	with
71	8	withgreyscale	with
77	0	within	within
71	12	withlinecap	with
71	13	withlinejoin	with
71	16	withmesh	with
71	14	withmiterlimit	with
71	5	withnestedpostscript	with
71	4	withnestedprescript	with
71	18	withnothing	with
71	7	withoutcolor	with
71	0	withpen	with
71	3	withpostscript	with
71	2	withprescript	with
71	10	withrgbcolor	with

71	6	withstacking	with
37	8	wpart	unary
32	0	write	write
40	120	xabsolute	cycle
37	5	xpart	unary
37	104	xrange	unary
40	117	xrelative	cycle
60	156	xscaled	secondarybinary
37	9	xxpart	unary
40	122	xyabsolute	cycle
37	10	xypart	unary
40	119	xyrelative	cycle
60	159	xyscaled	secondarybinary
40	121	yabsolute	cycle
37	18	yellowpart	unary
37	6	ypart	unary
37	105	yrange	unary
40	118	yrelative	cycle
60	157	yscaled	secondarybinary
37	11	yxpart	unary
37	12	ypart	unary
37	7	zpart	unary
60	158	zscaled	secondarybinary
50	0	{	leftbrace
70	0	}	rightbrace

Variables are of a certain type. Possible variable types are available in `metapost.types` via numeric and verbose keys: 0: undefined, 1: vacuous, 2: boolean, 3: unknownboolean, 4: string, 5: unknownstring, 6: pen, 7: unknownpen, 8: nep, 9: unknownnep, 10: path, 11: unknownpath, 12: picture, 13: unknownpicture, 14: transform, 15: color, 16: cmykcolor, 17: pair, 18: numeric, 19: known, 20: dependent, 21: protodependent, 22: independent, 23: tokenlist, 24: structured, 25: unsuffixedmacro, 26: suffixedmacro.

The possible command codes (as seen in the primitive table) are available in `metapost.codes` via numeric and verbose keys: 0: undefined, 1: btex, 2: etex, 3: if, 4: fiorelse, 5: input, 6: iteration, 7: repeatloop, 8: exittest, 9: relax, 10: scantokens, 11: runscript, 12: maketext, 13: expandafter, 14: definedmacro, 15: save, 16: interim, 17: let, 18: newinternal, 19: newbytemap, 20: macrodef, 21: shipout, 22: addto, 23: setbounds, 24: protection, 25: property, 26: show, 27: mode, 28: onlyset, 29: message, 30: everyjob, 31: delimiters, 32: write, 33: typename, 34: leftdelimiter, 35: begingroup, 36: nullary, 37: unary, 38: str, 39: void, 40: cycle, 41: ofbinary, 42: capsule, 43: string, 44: internal, 45: tag, 46: numeric, 47: plusorminus, 48: secondarydef, 49: tertiarybinary, 50: leftbrace, 51: pathjoin, 52: pathconnect, 53: ampersand, 54: tertiarydef, 55: primarybinary, 56: equals, 57: and, 58: primarydef, 59: slash, 60: secondarybinary, 61: parametertype, 62: controls, 63: tension, 64: atleast, 65: curl, 66: macrospecial, 67: rightdelimiter, 68: leftbracket, 69: rightbracket, 70: rightbrace, 71: with, 72: thingstoadd, 73: of, 74: to, 75: step, 76: until, 77: within, 78: assignment, 79: colon, 80: comma, 81: semicolon, 82: endgroup, 83: stop, 84: undefinedcs.

When you scan for input not all of these make sense, often you will stick to dealing with symbols like brackets, braces, equal signs and variables or expressions.

23.7 Scanners

The most low level scanners are `token` and `symbol`. Although we have them in the `mp.scan` namespace they are just library calls. You use them like:

```
if scan.symbol(true) == "[" then -- "]"
    scan.symbol()
else
    ...
end
```

Here we check if the upcoming token is a specific symbol. The `true` will push back the token. A second boolean argument will enforce expansion.

Scanning can be hairy because the engine is set up in a way that mix lookahead, expand, resolve and processing. So, you can run into a numeric constant, but also in a not yet resolved quantity (take = versus :=). When writing more complex scanners it helps to print codes and types.

The `scan.token` function returns a command, mode and expression type but in practice you only have to consider the first value. Other scanners are `boolean`, `cmykcolor`, `color`, `expression`, `integer`, `next`, `number`, `numeric`, `pair`, `path`, `pen`, `property`, `string`, `transform`, plus some implemented around these. Keep in mind that scanners are bound to an instance so the functions in the `scan` namespace are actually wrappers around the library calls.

Because some tokens trigger further scanning (e.g. expressions) we also have two dedicated sub tables with scanners: `tokenscanners` and `typescanners` where, when indexed with a token (command) or type you get the appropriate scanner to get a real result. When you look at what is built into ConT_EXt you will notice that we often look ahead and then trigger the appropriate scanner. This approach permits to come up with syntaxes that are different than what MetaPost normally does, so for instance brackets and braces can be used to fence parameters and collections, while lists of comma separated numbers can be grabbed that are not part of pairs, triplets, quadruples etc.

23.8 Special helpers

23.8.1 Hashes

This is typically one of the examples that popped up when Alan Braslau and I were exploring the new possibilities. Due to the way MetaPost implements hashes using Lua might turn out to be more efficient. Here are some examples:

```
\startMPcode
%     newhash("foo") ;
    tohash("foo","bar","gnu") ;
    tohash("foo","rab","ung") ;
    fill fullcircle scaled 1cm withcolor "lightgray" ;
    draw texttext(fromhash("foo","bar")) ;
    draw texttext(fromhash("foo","rab")) rotated 90 ;
    disposehash("foo") ;
```

`\stopMPcode`



In this example we allocate a hash and afterwards get rid of it. When you don't allocate one it will be automatically allocated. Hashes are persistent, so if you want to be sure you start fresh you'd better create one explicitly. And if you use a large one, you'd better clean up afterwards.⁴

`\startMPcode`

```
resethash("foo")
tohash("foo",1,"gnu") ;
tohash("foo",2,"ung") ;
fill fullcircle scaled 1cm withcolor "lightgray" ;
for i=1 upto 3 :
  if inhash("foo",i) :
    draw texttext(fromhash("foo",i))
      rotated ((i-1) * 90) ;
  fi ;
endfor ;
```

`\stopMPcode`



Here we check if something is present in a hash. This example also demonstrates that we can use numbers as key. And yes, you can also use boolean keys:

`\startMPcode`

```
resethash("foo")
tohash("foo",false,"gnu") ;
tohash("foo",true,"ung") ;
fill fullcircle scaled 1cm withcolor "lightgray" ;
draw texttext(fromhash("foo",false)) ;
draw texttext(fromhash("foo",true)) rotated 90 ;
```

`\stopMPcode`



Looking at the implementation of these macros (at the MetaPost end) and functions (at the Lua end) will give you an idea how all these interfaces work together.

23.8.2 Modes

You can query the modes set at the TeX end. You can also check the systemmode.

`\enablemode`[weird]

⁴ In MkXL the newhash macro is no longer needed to get a unique index.

```

\startMPcode
  fill fullsquare xyscaled (TextWidth,5mm)
    withcolor if texmode("weird") : "darkblue" else : "darkgreen" fi ;
\stopMPcode
\disablemode[weird]
\startMPcode
  fill fullsquare xyscaled (TextWidth,5mm)
    withcolor if texmode("weird") : "darkblue" else : "darkgreen" fi ;
\stopMPcode

```



23.8.3 Positions

Keeping track of positions is a core feature and accessible in MetaPosttoo. Here is a somewhat weird example. Positions are always relative to a region, normally the page, but here we provide one via `\framed`.

```

\framed [region=MyRegion,offset=overlay,width=1tw] \bgroup \hpos {here} \bgroup
  \startMPcode
    fill fullcircle scaled 10mm
      withcolor "darkblue" ;
    draw positionxy("here")
      shifted - positionxy("MyRegion")
      withpen pencircle scaled 2mm
      withcolor "darkred" ;
    draw positionxy("here")
      shifted - positionxy("MyRegion")
      shifted (wdpart positionwhd("MyRegion"),0)
      withpen pencircle scaled 5mm
      withcolor "darkgreen" ;
    % otherwise we oscillate
    setbounds currentpicture to
      fullcircle scaled 10mm ;
  \stopMPcode
\egroup \egroup

```



<code>positionanchor</code>	string
<code>positionbox</code>	path using connector --
<code>positioncolumn</code>	numeric
<code>positioncurve</code>	path using connector ..
<code>positiondepth</code>	numeric
<code>positionhangafter</code>	numeric
<code>positionhangindent</code>	numeric
<code>positionheight</code>	numeric

positionhsize	numeric
positionleftskip	numeric
positionllx	numeric
positionlly	numeric
positionlowerleft	pair
positionlowerright	pair
positionpage	numeric
positionparagraph	numeric
positionparindent	numeric
positionpath	path using connector --
positionpx	numeric
positionpxy	pair
positionpy	numeric
positionregion	string
positionrightskip	numeric
positionupperleft	pair
positionupperright	pair
positionurx	numeric
positionury	numeric
positionwhd	(wd,ht,dp)
positionwidth	numeric

Positioning can be tricky. You really need to make sure that the bounding box of the result is right because when it changes, positions also change you get cyclic runs and quite possible graphics that get larger and larger.

23.8.4 T_EX quantities

You can set and get some of T_EX's internal quantities:

```
\scratchdimen=100pt \scratchcounter=250 \scratchtoks={okay} \def\Good{good}
\startMPcode
draw texttext(getdimen("scratchdimen"))   shifted (0cm,0) withcolor "darkblue" ;
draw texttext(getcount("scratchcounter"))  shifted (3cm,0) withcolor "darkred" ;
draw texttext(gettoks ("scratchtoks"))     shifted (6cm,0) withcolor "darkgreen" ;
draw texttext(getmacro("Good"))            shifted (9cm,0) withcolor "darkyellow"
;
\stopMPcode

99.62640099626401      250          okay          good
```

Valid getters are getmacro, getdimen, getcount and gettoks and their counterparts are set... and setglobal... Instead of names you can use numbers for registers, but don't mess up the system ones:

```
\startMPcode
setdimen(2,2*100pt) setcount(2,2*250) settoks(2,"OKAY") setmacro("Good","GOOD")
draw texttext(getdimen(2))      shifted (0cm,0) withcolor "darkblue" ;
draw texttext(getcount(2))      shifted (3cm,0) withcolor "darkred" ;
draw texttext(gettoks (2))      shifted (6cm,0) withcolor "darkgreen" ;
```

```
draw texttext(getmacro("Good")) shifted (9cm,0) withcolor "darkyellow" ;
\stopMPcode
```

199.25199629806195 500 OKAY GOOD

23.8.5 UTF8

Because we use an utf8 engine we also have MetaPost accepting that encoding. The normal string primitives are unchanged and operate on (ascii) bytes but we have some additional helpers (and more might show up if needed). Here is an example:

```
\startMPcode
string s ; s := "ÅÃÄÅÄåääää" ;
draw texttext(s) shifted ( 0cm,0) withcolor "darkyellow" ;
draw texttext(utfnum("Å")) shifted ( 3cm,0) withcolor "darkmagenta" ;
draw texttext(utflen(s)) shifted ( 6cm,0) withcolor "darkcyan" ;
draw texttext(utfsub(s,3,4)) shifted ( 9cm,0) withcolor "darkblue" ;
draw texttext(utfsub(s,6)) shifted (12cm,0) withcolor "darkred" ;
\stopMPcode
```

ÅÃÄÅÄåääää 194 12 ÅÃ Åääääää

23.8.6 Checkers

There are a couple of checkers, mostly used in modules. Here's are a few that Alan needs for the node module:

```
\startMPcode
draw image (
draw texttext(if isarray p[1][2] : "Y__" else : "N__" fi) ;
draw texttext(if isarray p[1] : "_Y_" else : "_N_" fi) ;
draw texttext(if isarray p : "__Y" else : "__N" fi) ;
) xsize 3cm withcolor "darkred" ;
\stopMPcode
```

Y Y N
 _ _ _

```
\startMPcode
draw image (
draw texttext(prefix p[1][2]) shifted (10,0) withcolor "darkred" ;
draw texttext(prefix p[1] ) shifted (20,0) withcolor "darkgreen" ;
draw texttext(prefix p ) shifted (30,0) withcolor "darkblue" ;
) ysize 12mm ;
\stopMPcode
```

p p p

```

\startMPcode
  draw image (
    draw texttext(dimension p[1][2]) shifted (10,0) withcolor "darkred" ;
    draw texttext(dimension p[1]   ) shifted (20,0) withcolor "darkgreen" ;
    draw texttext(dimension p     ) shifted (30,0) withcolor "darkblue" ;
  ) ysized 12mm ;
\stopMPcode

```

2 1 0

```

\startMPcode
  picture p ; p := texttext("some text") ;
  path q ; q := fullcircle scaled 3cm ;
  draw texttext(tostring(isobject(p))) withcolor "darkgreen" ;
  draw texttext(tostring(isobject(q))) shifted (50,0) withcolor "darkblue" ;
\stopMPcode

true false

```

23.8.7 Key-value interfaces

There are plenty of examples in the `mp-lmtx.mpxl` file and more will be added. Just make sure you create your own unique namespace and don't use the ones that ConT_EXt uses (like `lmt_`).

24 Bytemaps

In this chapter we explore bytemaps, which essentially are arrays of bytes that can be used to store states. There are two variants: single bytes and triplets, or in MetaPost speak: numerics or colors. The reason why we added this to the engine is that we expect these to be used in situations where storing states efficiently makes sense. The results can of course be bitmaps but also become a path.

In the following example we create three bytemaps: one with a single row of bytes, one with ten rows and columns black and white, and a same size bytemap with three color components.

```
\startMPcode
newbytemap 1 of 10;
newbytemap 2 of (10,10);
newbytemap 3 of (10,10,3);

for i=1 upto 3 :

  setbytemap i to 100 ;

  setbyte (0,0) of i to 150 ;
  setbyte (1,1) of i to 200 ;

  setbyte (8,0) of i to (150,150,0) ;
  setbyte (6,2) of i to (150,0,150) ;

  setbyte (3,3,1,2) of i to 150 ;
  setbyte (7,7,2,2) of i to (0,150,150) ;

  setbyte (2,7,1) of i to 0 ;
  setbyte (2,7,2) of i to 0 ;
  setbyte (2,7,0) of i to 255 ;

  fill
    unitsquare scaled 100
    shifted ((i-1)*110,0)
    withbytemap i ;

endfor ;
\stopMPcode
```

When the `setbyte` command gets two arguments, they indicate the coordinates. When a third argument is passed, it specifies the (color) channel. When four arguments are passed, the last two indicate the width and height of the area to be set. When a color is assigned to a singly byte pane the color gets reduced to a gray scale.

A bytemap is drawn using a path and `withbytemap` specifier. A `fill` create a tight result, while a `draw` adds half the pen to the dimensions.

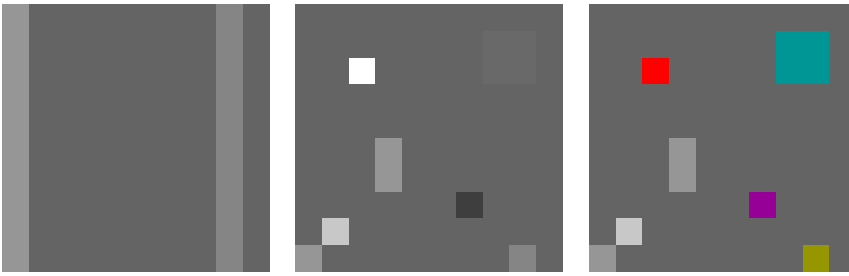

Before we show some more methods, we will do the same as above from the Lua end.

```

\startluacode
local random = math.random
local setbytemap = mp.setbytemap

function MP.MakeByteMap(i)
  mp.newbytemap(i,200,50,3)
  mp.fillbytemap(i,100,100,100)
  for j=1,5000 do
    setbytemap(i,
      random(0,199), random(0,49),
      random(0,255), random(0,255), random(0,255)
    )
  end
end
\stopluacode

```

Next we use this Lua function:

```

\startMPcode
lua.MP.MakeByteMap(4);

fill
  unitsquare xyscaled (200,50)
  withbytemap 4 ;
\stopMPcode

```

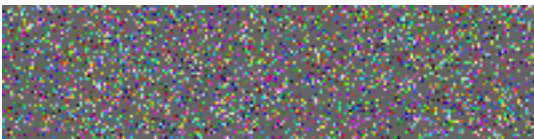

Instead of a bitmap you can also get a path:

```

\startluacode
local random = math.random
local setbytemap = mp.setbytemap

function MP.MakeBytePath(i)
  mp.newbytemap(i,100,100,1)
  mp.fillbytemap(i,100)
  for j=1,2500 do

```

```

        setbytemap(i,
            random(0,99),
            random(0,99),
            random(1,10)
        )
    end
end
\stopluacode

```

This function will fill a gray scale bytemap. We can filter the values and turn the result into a path:

```

\startMPcode
lua.MP.MakeBytePath(5);

picture p[] ;

p[1] := image (
    for i=1 upto 10 :
        if bytefound i of 5 :
            drawdot (bytepath i of 5) shifted (.5,.5)
            withpen pencircle scaled (i/2) ;
        fi ;
    endfor ;
) ;

p[2] := image (
    for i=1 step 2 until 10 :
        if bytefound (i,i+1) of 5 :
            drawdot (bytepath (i,i+1) of 5) shifted (.5,.5)
            withpen pencircle scaled ((i+.5)/2) ;
        fi ;
    endfor ;
) ;

draw p[1] withcolor red withtransparency (1,.5) ;
draw p[2] shifted (110,0) withcolor green withtransparency (1,.5) ;
draw p[1] shifted (220,0) withcolor blue withtransparency (1,.5) ;
draw p[2] shifted (220,0) withcolor yellow withtransparency (1,.5) ;
\stopMPcode

```

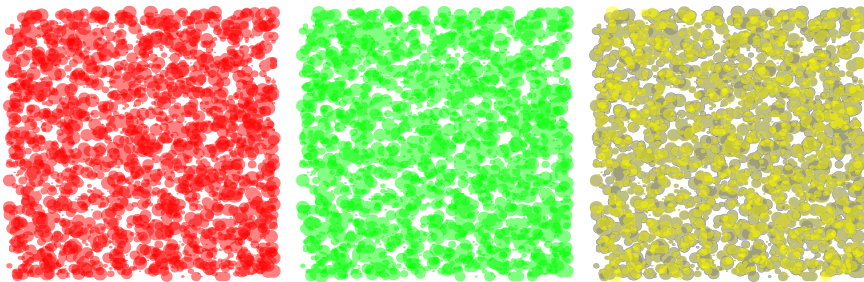

You can of course fill a bytemap with more meaningful data, as in:

```

\startMPcode

```

```

newbytemap 1 of (100,102) ;
setbyte (0,0,100,102) of 1 to 150 ;

for i=0 upto 99 :
    setbyte(i,99*sin((i/99)*pi),2,4) of 1 to (2.55*i) ;
endfor ;

fill unitsquare xyscaled (400,100) withbytemap 1 ;
\stopMPcode

```

And just show the result as it is. Here we fill small areas:



These bytemaps are not implemented as datatype because it would not only complicate matters but also be inconsistent with for instance equations and scanning. The interface more looks like function calls. Currently we have these, but more (variants) might show up:

```

newbytemap      index of (nx,ny) ;
newbytemap      index of (nx,ny,nz) ;
copybytemap     index to m ;
resetbytemap    index ;
resetbytemaps   ;
setbytemap      index to value;
setbytemap      index to (r,g,b);

setbytemapoption of index to n ;
setbytemapoffset of index to (x,y) ;
reducebytemap   of index ;
setbyte         (x,y) of index to value ;
setbyte         (x,y) of index to (r,g,b) ;
setbyte         (x,y,z) of index to value ;
setbyte         (x,y,z) of index to (r,g,b) ;
setbyte         (x,y,dx,dy) of index to value ;
setbyte         (x,y,dx,dy) of index to (r,g,b) ;

withbytemap     index
withbytemask    value
bytevalue       (x,y) of index
bytevalue       (x,y,[z]) of index
bytefound       value of index
bytefound       (min,max) of index
bytepath        value of index
bytepath        (min,max) of index

```

The `withbytemask` directive is not really a primitive but a backend option instead.

Currently the following Lua functions are available:

```
mp.newbytemap      (nx,ny,nz)
mp.setbytemap      (x,y,value)
mp.setbytemap      (x,y,r,g,b)
mp.getbytemap      (x,y)
mp.getbytemap      (x,y,z)
mp.fillbytemap     (x,y,value)
mp.fillbytemap     (x,y,r,g,b)
```

```
mp.getbytemapdata ()      : return nx, ny, nz
mp.getbytemapdata (true) : return nx, ny, nz, data
```

These use the `mp.lib` library functions that expect an instance as argument but in the `ConTeXt mp` library that is taken care of automatically.

You can stack a bitmap result on top of another object without it covering that object by using the `withbytemask` directive.

```
\startMPcode
newbytemap 2 of (10,10,3);

setbytemap 2 to (100,0,0) ;

fill unitcircle scaled 100 withcolor blue ;
fill unitsquare scaled 100 shifted (110,0) withbytemap 2 ;
fill unitcircle scaled 100 shifted (220,0) withcolor blue ;
fill unitsquare scaled 100 shifted (220,0) withbytemap 2 withbytemask 100 ;
\stopMPcode
```



You can clip a bytemap to what actually is used.

```
\startMPcode
newbytemap 4 of (4,4) ;
setbytemap 4 to 255 ;

setbyte (1,1) of 4 to 100 ;
setbyte (1,2) of 4 to 200 ;
setbyte (2,1) of 4 to 200 ;
setbyte (2,2) of 4 to 100 ;

pickup pencircle scaled 2;
```

```

fill unitsquare scaled 100 withbytemap 4 ;
draw unitsquare scaled 100 withcolor "darkred" ;

path b ; b := bytemapbounds 255 of 4;

message (llcorner b); % metapost > message 1 1
message (urcorner b); % metapost > message 2 2

copybytemap 4 to 5 ;
clipbytemap 5 to 255 ;

fill unitsquare scaled 100 shifted (110,0) withbytemap 5 ;
draw unitsquare scaled 100 shifted (110,0) withcolor "darkblue" ;
\stopMPcode

```

Here we copy the bytemap because we want to show the original and when we draw (fill) the bytemap we only add a reference so the bitmap that gets embedded is the last one assigned to that slot!

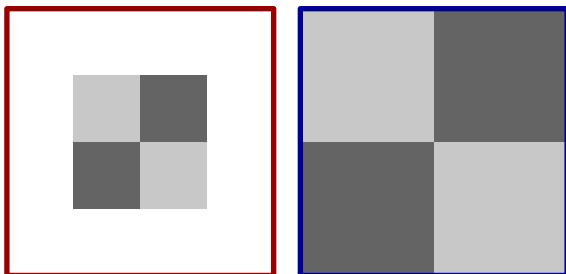

In LuaMetaFun you can use Potrace to turn a bitmap into an outline and bytemaps can be a source too:

```

\startMPcode
newbytemap 1 of (10,10) ;
setbytemap 1 to 100 ;

for i=2 upto 8 :
  for j=2 upto 8 :
    setbyte (i,j) of 1 to 200 ; % 49 "1"
  endfor ;
endfor ;
for i=3 upto 7 :
  for j=3 upto 7 :
    setbyte (i,j) of 1 to 150;
  endfor ;
endfor ;

picture p[] ;

p[1] := image (
  fill unitsquare ysize 50 withbytemap 1 ;
);

p[2] := image (
  draw lmt_potraced [
    explode = true,

```

```

        value = (char 200), % "1",
        bytemap = 1
] ysize 50
withcolor "darkblue"
withpen pencircle scaled 1 ;
);

p[3] := image (
  draw lmt_potraced [
    explode = true,
    value = (char 150),
    bytemap = 1
  ] ysize 50
  withcolor "darkred"
  withpen pencircle scaled 1 ;
);

for i=1 upto 3 :
  draw p[i]
  shifted - center p[i]
  shifted ((i-1) * 60,0)
;
endfor ;
\stopMPcode

```

You need to scald these images to your needs; here we just normalize them to the same size. Of course you might need to fine tune the tracing.

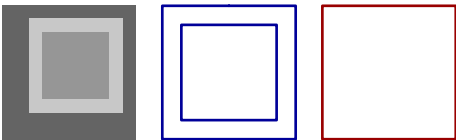

You can also load a bitmap from file, for instance:

```

\startMPcode
triplet bm ; bm := loadbytemapfromfile(3, "mill.png") ;
numeric nx ; nx := redpart bm;
numeric ny ; ny := greenpart bm;

newinternal v ;
for col=nx/3 upto 2nx/3 :
  for row=ny/3 upto 2ny/3 :
    v := bytevalue (col,row) of 3 ;
    if (v > 50) and (v < 150) :
      setbyte (col,row) of 3 to 255 ;
    fi
  endfor ;
endfor ;

draw image (

```

```

fill unitsquare xyscaled (nx,ny)
  withbytemap 3 ;
draw unitsquare xyscaled (nx/3,ny/3)
  shifted (nx/3,ny/3)
  withpen pencircle scaled 5
  withcolor "darkred" ;
) ysize 8cm ;
\stopMPcode

```

Of course manipulating bitmaps will add to the the runtime but in this case it can be neglected (see figure 24.1).

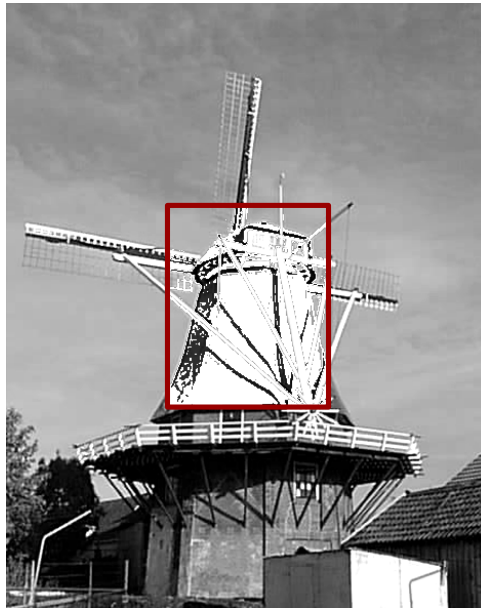

Figure 24.1 A bytemap loaded from file.

Here are a few more examples. We fill a few areas first. Of course this can be done with regular paths but imagine more complex patterns. We make a copy of that bytemap and then convert the pixels to gray scales:

```

\startMPcode
newbytemap 4 of (50,50,3) ;

setbyte (1,1,47,47) of 4 to (0,200,0) ;
setbyte (5,5,42,42) of 4 to (0,0,200) ;
setbyte (9,9,34,34) of 4 to (200,0,0) ;

fill unitsquare
  scaled 50
  withbytemap 4 ;

copybytemap 4 to 8;

reducebytemap 8;

fill unitsquare

```

```

scaled 50 shifted (55,0)
withbyte map 8 ;
\stopMPcode

```

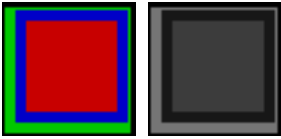

This example shows how to use an offset (which can save some calculations) as well as the fact that we can rotate a bitmap (see figure 24.2).

```

\startMPcode
newbyte map 3 of (100,100,3) ;
setbyte map 3 to 50 ;
setbyte map offset (1,1) of 3;
numeric n ;
for i=1 step 5 until 100 :
  n := 100 ;
  for j=1 step 5 until 100 :
    setbyte (i,j) of 3 to n ;
    n := n + 5 ;
  endfor ;
endfor ;

draw unitsquare
scaled 200
rotated 45
withbyte map 3 ;
\stopMPcode

```

We store bytes which normally represent a small integer value, or in our case an unsigned cardinal (in Modula speak). However, we can also use that byte for storing a small float, in our case a posit. The number of possible values is of course limited, as can be seen in table 24.1.

In order to get this working, we need to set option 2, as in the following example.⁵ Because we use small values, we get a rather dark result but we can expand the bitmap.

```

\startMPcode
newbyte map 1 of (10,10) ;
setbyte map options 1 to 2 ;
% setbyte map 1 to 255 ;
% setbyte map 1 to 1.5 ;
for i=0 upto 9 :
  for j=0 upto 9 :
    n := uniformdeviate(1) ;
    setbyte (i,j) of 1 to n ;
    % show((n,bytevalue (i,j) of 1)) ;
  endfor ;
endfor ;

```

⁵ Options are a bitset. Option 1 makes a bytemap persistent across figures, and is handy when you want to access it later on.

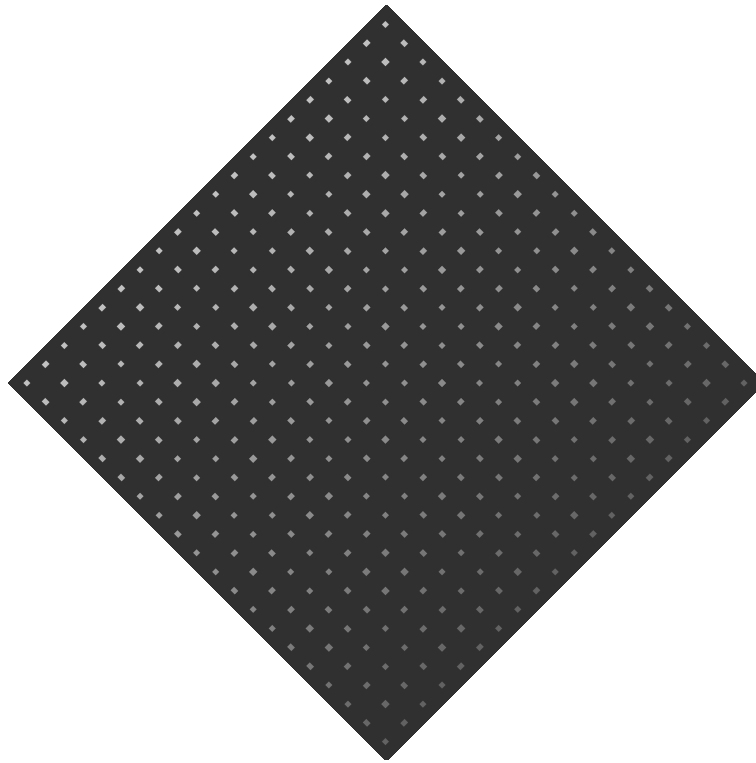

Figure 24.2 Using offset.

```

endfor ;

draw image (
  draw unitsquare          withbyte 1 ;
  draw unitsquare shifted (1.1,0) withbyte 1 withbyteexpansion 127 ;
  draw unitsquare shifted (2.2,0) withbyte 1 withbyteexpansion 255 ;
) scaled 100;
\stopMPcode

```

This expansion option is mostly there because of tracing (and showing off in the manual) but we can imagine users finding some application.

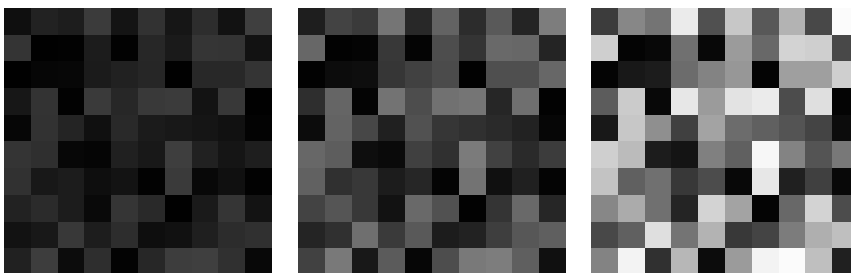

The next code produces figure 24.3 which demonstrates that we get back a float instead of an integer in some cases. Posits (for now) only make sense for numeric bytemaps.

```
\startMPcode
```

0.0	00	0.671875	2B	1.6875	56	-64.0	81	-1.625	AC	-0.640625	D7
0.015625	01	0.6875	2C	1.71875	57	-32.0	82	-1.59375	AD	-0.625	D8
0.03125	02	0.703125	2D	1.75	58	-24.0	83	-1.5625	AE	-0.609375	D9
0.046875	03	0.71875	2E	1.78125	59	-16.0	84	-1.53125	AF	-0.59375	DA
0.0625	04	0.734375	2F	1.8125	5A	-14.0	85	-1.5	B0	-0.578125	DB
0.078125	05	0.75	30	1.84375	5B	-12.0	86	-1.46875	B1	-0.5625	DC
0.09375	06	0.765625	31	1.875	5C	-10.0	87	-1.4375	B2	-0.546875	DD
0.109375	07	0.78125	32	1.90625	5D	-8.0	88	-1.40625	B3	-0.53125	DE
0.125	08	0.796875	33	1.9375	5E	-7.5	89	-1.375	B4	-0.515625	DF
0.140625	09	0.8125	34	1.96875	5F	-7.0	8A	-1.34375	B5	-0.5	E0
0.15625	0A	0.828125	35	2.0	60	-6.5	8B	-1.3125	B6	-0.484375	E1
0.171875	0B	0.84375	36	2.125	61	-6.0	8C	-1.28125	B7	-0.46875	E2
0.1875	0C	0.859375	37	2.25	62	-5.5	8D	-1.25	B8	-0.453125	E3
0.203125	0D	0.875	38	2.375	63	-5.0	8E	-1.21875	B9	-0.4375	E4
0.21875	0E	0.890625	39	2.5	64	-4.5	8F	-1.1875	BA	-0.421875	E5
0.234375	0F	0.90625	3A	2.625	65	-4.0	90	-1.15625	BB	-0.40625	E6
0.25	10	0.921875	3B	2.75	66	-3.875	91	-1.125	BC	-0.390625	E7
0.265625	11	0.9375	3C	2.875	67	-3.75	92	-1.09375	BD	-0.375	E8
0.28125	12	0.953125	3D	3.0	68	-3.625	93	-1.0625	BE	-0.359375	E9
0.296875	13	0.96875	3E	3.125	69	-3.5	94	-1.03125	BF	-0.34375	EA
0.3125	14	0.984375	3F	3.25	6A	-3.375	95	-1.0	C0	-0.328125	EB
0.328125	15	1.0	40	3.375	6B	-3.25	96	-0.984375	C1	-0.3125	EC
0.34375	16	1.03125	41	3.5	6C	-3.125	97	-0.96875	C2	-0.296875	ED
0.359375	17	1.0625	42	3.625	6D	-3.0	98	-0.953125	C3	-0.28125	EE
0.375	18	1.09375	43	3.75	6E	-2.875	99	-0.9375	C4	-0.265625	EF
0.390625	19	1.125	44	3.875	6F	-2.75	9A	-0.921875	C5	-0.25	F0
0.40625	1A	1.15625	45	4.0	70	-2.625	9B	-0.90625	C6	-0.234375	F1
0.421875	1B	1.1875	46	4.5	71	-2.5	9C	-0.890625	C7	-0.21875	F2
0.4375	1C	1.21875	47	5.0	72	-2.375	9D	-0.875	C8	-0.203125	F3
0.453125	1D	1.25	48	5.5	73	-2.25	9E	-0.859375	C9	-0.1875	F4
0.46875	1E	1.28125	49	6.0	74	-2.125	9F	-0.84375	CA	-0.171875	F5
0.484375	1F	1.3125	4A	6.5	75	-2.0	A0	-0.828125	CB	-0.15625	F6
0.5	20	1.34375	4B	7.0	76	-1.96875	A1	-0.8125	CC	-0.140625	F7
0.515625	21	1.375	4C	7.5	77	-1.9375	A2	-0.796875	CD	-0.125	F8
0.53125	22	1.40625	4D	8.0	78	-1.90625	A3	-0.78125	CE	-0.109375	F9
0.546875	23	1.4375	4E	10.0	79	-1.875	A4	-0.765625	CF	-0.09375	FA
0.5625	24	1.46875	4F	12.0	7A	-1.84375	A5	-0.75	D0	-0.078125	FB
0.578125	25	1.5	50	14.0	7B	-1.8125	A6	-0.734375	D1	-0.0625	FC
0.59375	26	1.53125	51	16.0	7C	-1.78125	A7	-0.71875	D2	-0.046875	FD
0.609375	27	1.5625	52	24.0	7D	-1.75	A8	-0.703125	D3	-0.03125	FE
0.625	28	1.59375	53	32.0	7E	-1.71875	A9	-0.6875	D4	-0.015625	FF
0.640625	29	1.625	54	64.0	7F	-1.6875	AA	-0.671875	D5		
0.65625	2A	1.65625	55	nan	80	-1.65625	AB	-0.65625	D6		

Table 24.1 Possible float values in a bytemap.

```

newbytemap 1 of (20,5) ;
setbytemapoptions 1 to 2 ;
setbytemap 1 to 0 ;
for i=0 upto 19 :
  for j=0 upto 4 :
    n := 0 randomized 10 ;
    setbyte (i,j) of 1 to n ;

```

```

        % show((n,bytevalue (i,j) of 1)) ;
    endfor ;
endfor ;

pickup pencircle scaled 2 ;
drawdot (bytepath (1,2) of 1) scaled 10 withcolor "darkred" ;
drawdot (bytepath (2,3) of 1) scaled 10 withcolor "darkgreen" ;
drawdot (bytepath (3,4) of 1) scaled 10 withcolor "darkblue" ;

for i=0 upto 19 :
    for j=0 upto 4 :
        n := bytevalue (i,j) of 1;
        draw
            texttext (decimal n)
                scaled .2
                shifted (10i,10j-3)
        ;
    endfor ;
endfor ;
\stopMPcode

```

A nice aspect of posits is that a comparison is very fast because we can directly compare the integer representation. Another advantage over for instance so called minifloats is that they waste less on NaN and Infinity as well as are most accurate in the smaller values.

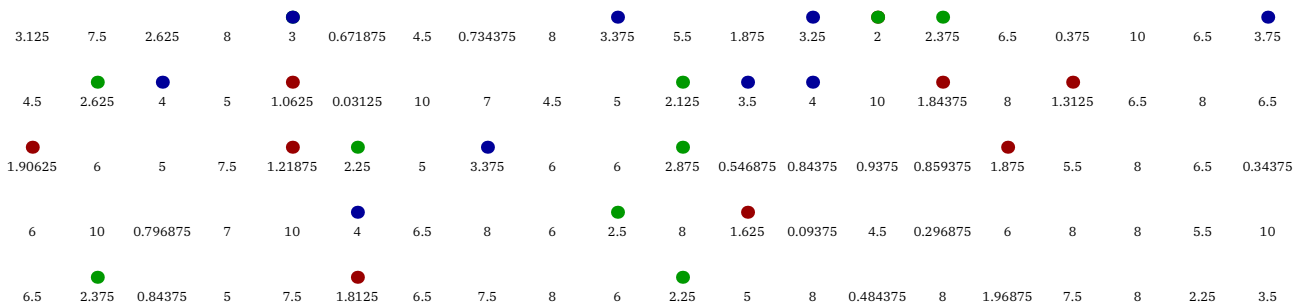

Figure 24.3 Some operations return posits.

Filing a bytemap with values can be done with a MetaPost loop or at the Lua end. A rather convenient variant is using a function and delate the loop to the engine. This is more efficient when we also need access to the currently set values. Here are some examples:

```

\startluacode
local round = math.round
local random = math.random

function MP.bw_inverse(x,y,s)
    return 255 - s
end
function MP.bw_darker(x,y,s)
    return 0.8 * s
end
function MP.bw_grain(x,y,s)
    return s - 25 + random(50)

```

```

    end
\stopluacode

\startMPcode
triplet bm ; bm := loadbytemapfromfile(1, "mill.png") ;
copybytemap 1 to 2;
copybytemap 1 to 3;
copybytemap 1 to 4;
draw lmt_bytemap [
    bytemap      = 1,
] bytemapscaled 1 x sized .25TextWidth ;
draw lmt_bytemap [
    bytemap      = 2,
    colorfunction = "bw_inverse",
] bytemapscaled 1 x sized .25TextWidth xshifted .25TextWidth;
draw lmt_bytemap [
    bytemap      = 3,
    colorfunction = "bw_darker",
] bytemapscaled 1 x sized .25TextWidth xshifted .50TextWidth;
draw lmt_bytemap [
    bytemap      = 4,
    colorfunction = "bw_grain",
] bytemapscaled 1 x sized .25TextWidth xshifted .75TextWidth;
\stopMPcode

```

The replacement happens in-place which is why we make some copied to work with.



Here we manipulated the existing bytes. In the next example we don't do that but nevertheless use the function approach:

```

\startluacode
function MP.bc_test(x,y,b1,b2,b3)
    return x/2, y/2, (x+y)/500
end
\stopluacode

```

Here we demonstrate the downsample feature. Doing that in pure Lua is actually not that slow but of course this one is faster.

```

\startMPcode
  newbyteMap 1 of (1000,1000,3) ;
  newbyteMap 2 of (1,1,1);
  picture p ; p := image ( draw lmt_byteMap [
    byteMap      = 1,
    colorfunction = "bc_test",
  ] ; ) ;
  downsamplebyteMap(1,2,40);
  copybyteMap 2 to 3 ;
  reducebyteMap 3;
  draw unitsquare byteMapscaled 1 x sized (TextWidth/3) withbyteMap 1 ;
  draw unitsquare byteMapscaled 1 x sized (TextWidth/3) shifted ( TextWidth/3,0
    ) withbyteMap 2 ;
  draw unitsquare byteMapscaled 1 x sized (TextWidth/3) shifted (2TextWidth/3,0
    ) withbyteMap 3 ;
\stopMPcode

```

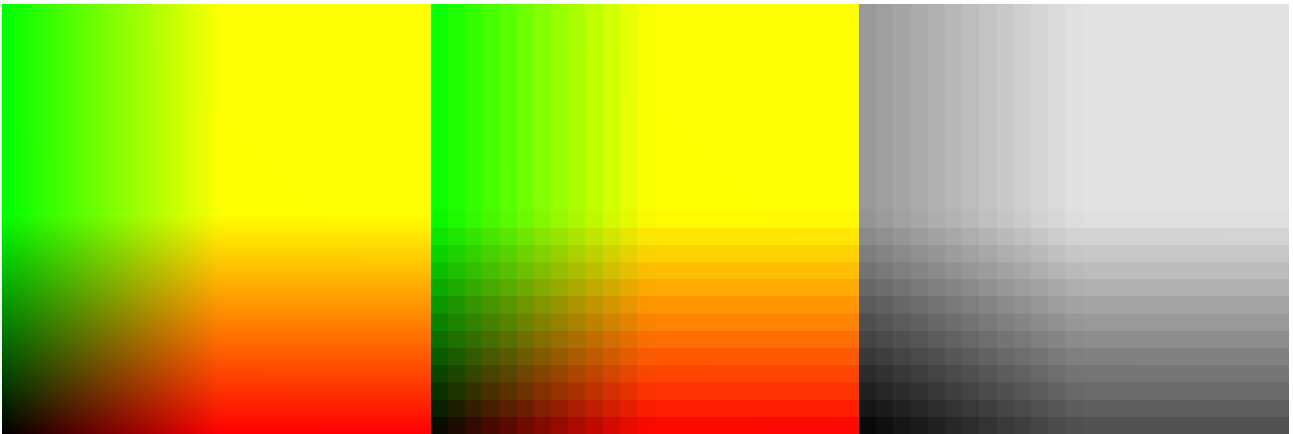

Here we apply downsampling to a ‘real’ image:

```

\startMPcode
  triplet bm ; bm := loadbyteMapfromfile(1, "mill.png") ;
  newbyteMap 2 of (1,1,1);
  downsamplebyteMap(1,2,2);
  draw unitsquare
    byteMapscaled 1 x sized .5 TextWidth
    withbyteMap 1
  ;
  draw unitsquare
    byteMapscaled 1 x sized .5TextWidth
    shifted (.5TextWidth,0)
    withbyteMap 2
  ;
\stopMPcode

```

Sampling takes the average of the given cell width, in this case 2. The result is normally quite okay.



Let's summarize some of these manipulations. Bytemaps are mostly there for special purposes and not so much for manipulating images that one normally would include with `\externalfigure`. One can fill a bytemap manually, from a lossless png file or a lossy jpg file. For runtime usage the bytemaps loaded from file can best not be too large. When the resolution is reasonable performance is quite ok. And if you're worried about a resolution, just think of the days that a few megapixel images were quite acceptable.

There are various ways to make a large bytemap a bit smaller. For instance, you can reduce the color range in the output file. Here we can either clip or round and in both cases an 8 bit color component becomes a 4 bit one. So, for every six bytes (two pixels) we get three bytes back. In practice, because we now have less distinctive values, compression also works out better.

`\startMPcode`

```
newbytemap 1 of (1,1,1) ;
newbytemap 2 of (1,1,1) ;
newbytemap 3 of (1,1,1) ;
loadbytemap (1,"hacker.jpg") ;
copybytemap 1 to 2 ;
copybytemap 1 to 3 ;
draw bytemap 1 xsize 3cm xshifted 0.0cm ;
draw bytemap 2 xsize 3cm xshifted 3.1cm withreduction "round" ;
draw bytemap 3 xsize 3cm xshifted 6.2cm withreduction "clip" ;
```

`\stopMPcode`

Reduction gives us:



Another way to reduce the size is downgrading. Here we also reduce the number of distinct values, and you can go pretty extreme here:

```
\startMPcode
  newbytemap 1 of (1,1,1) ;
  newbytemap 2 of (1,1,1) ;
  newbytemap 3 of (1,1,1) ;
  loadbytemap (1,"hacker.jpg") ;
  downgradebytemap (1,2,20) ;
  downgradebytemap (1,3,40) ;
  draw bytemap 1 xsize 3cm xshifted 0.0cm ;
  draw bytemap 2 xsize 3cm xshifted 3.1cm ;
  draw bytemap 3 xsize 3cm xshifted 6.2cm ;
\stopMPcode
```



A probably nicer result is possible with downsampling:

```
\startMPcode
  newbytemap 1 of (1,1,1) ;
  newbytemap 2 of (1,1,1) ;
  newbytemap 3 of (1,1,1) ;
  loadbytemap (1,"hacker.jpg") ;
  downsamplebytemap (1,2,2) ;
  downsamplebytemap (1,3,4) ;
  draw bytemap 1 xsize 3cm xshifted 0.0cm ;
  draw bytemap 2 xsize 3cm xshifted 3.1cm ;
  draw bytemap 3 xsize 3cm xshifted 6.2cm ;
\stopMPcode
```



In the next example we show a combination of effects: downsampling and using a palette:

```
\startluacode
  local sin = math.sin
  local cos = math.cos
  local p = { }
```

```

for i=0,255 do
  p[i] = { 255*sin(i), 255*cos(i), i }
end
figures.palettes.foo = p
\stopluacode

\startMPcode
  newbytemap 1 of (1,1,1) ;
  newbytemap 2 of (1,1,1) ;
  loadbytemap (1,"mill.png") ;
  downsamplebytemap (1,2,4) ;
  draw bytemap 1 xsized 7cm xshifted 0.0cm withpalette "foo" ;
  draw bytemap 2 xsized 7cm xshifted 7.2cm withpalette "foo" ;
\stopMPcode

```

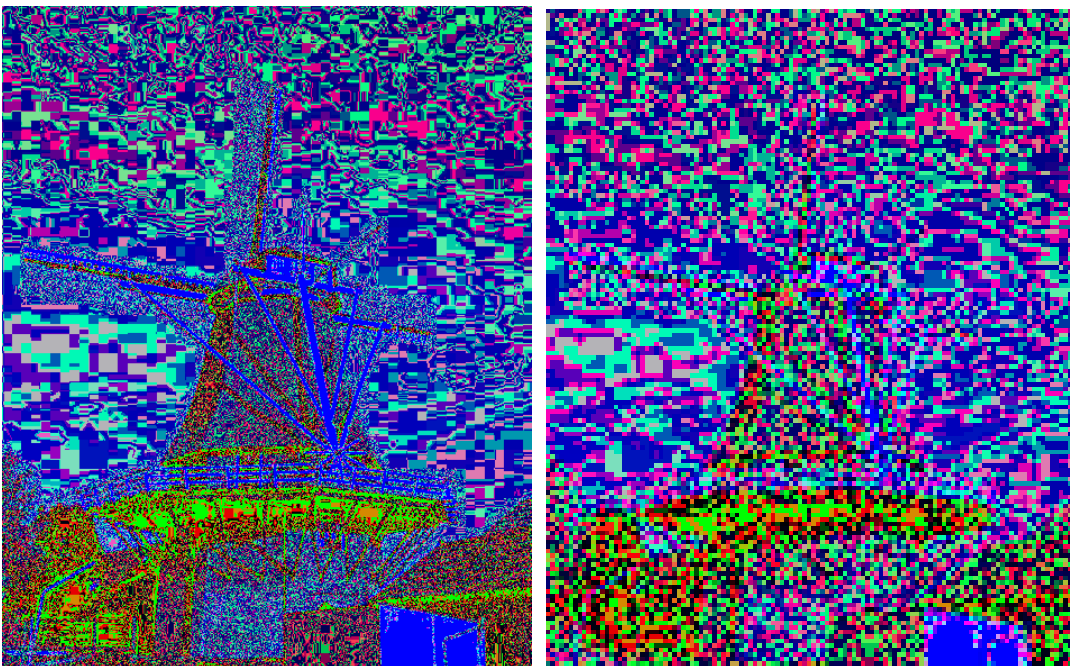

We have dedicated chapters to drawing functions but sometimes it makes sense to combine technologies. Take the following MetaPost code:⁶

```

\startMPpage
draw image (
  newinternal old, new;
  newinternal oldx, oldy;
  for r=2.75 step 0.001 until 4 :
    old := 0.2 ;
    oldx := 0;
    oldy := 0;
    for i=0 upto 800 :
      new := r*old*(1 - old);
      if i > 699 :

```

⁶ This is an example from Mikael's math book that we use for testing and benchmarks.

```

        if (abs(r-oldx) > 0.001) or (abs(old-oldy) > 0.001) :
            draw (r,old);
            oldx := r;
            oldy := old;
        fi
    fi
    old := new ;
endfor
endfor ;
) xsize 5.75cm withpen pencircle scaled .4 ;
\stopMPpage

```

This is an optimized version but even than on my current (2018) laptop it takes 2.170 seconds to get done. We can of course cache the result but then we still need to include a 500 MB pdf image, which also takes time. But we can do better!

```

\startluacode
local v0 <const> = 0
local v1 <const> = 200 -- 63
local v2 <const> = 225 -- 127

function MP.bifurkation(resolution,usemin)
    local bmp = bytemap.newdomain(2.75,4,0,1,resolution)
    local set = usemin and bmp.min or bmp.set
    for r = 2.75, 4, 0.002 do
        local old = 0.2
        for i = 0, 800 do
            local new = r * old * (1 - old)
            if i > 699 then
                set(r,old,v0,v1,v2)
            end
            old = new
        end
    end
    -- bmp.clip()
    mp.newbytemap(1,bmp.bytemap)
end
\stopluacode

```

In figures 24.4 and 24.5 we see a few renderings. These eight images took 0.199 seconds. A single 1000 cell instance takes 0.035 seconds:

```

\startMPpage
    lua.MP.bifurkation(1000,true) ;
    draw bytemap 1 xsize 5.75cm ;
\stopMPpage

```

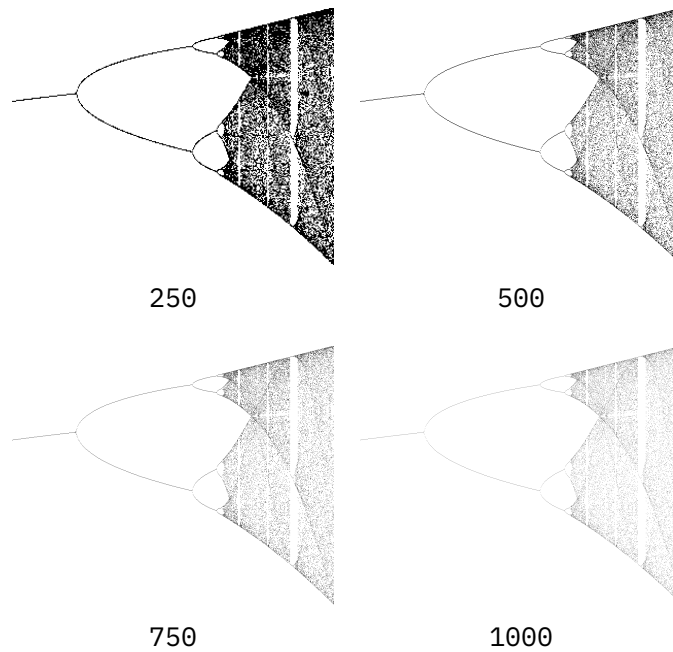

Figure 24.4 Bifurkation using set setter.

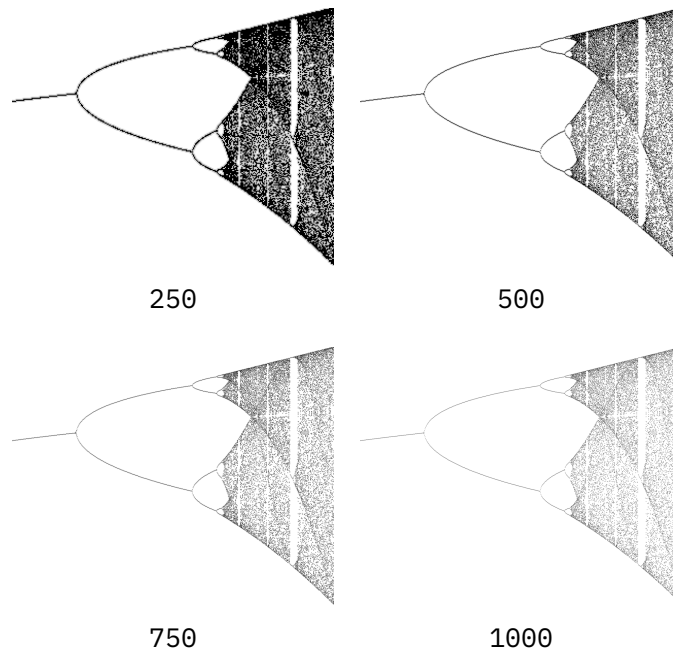

Figure 24.5 Bifurkation using min setter.

The `newdomain` function call returns a table with the following fields:

<code>bytemap</code>	the bytemap user data object
<code>sx</code>	the horizontal multiplier
<code>sy</code>	the vertical multiplier
<code>xy(x,y)</code>	the scaler (returns x and y)
<code>get(x,y)</code>	return the current value (byte)
<code>set(x,y,v)</code>	sets a point to a value (one byte)
<code>min(x,y,v0,v1,v3)</code>	sets a point to a value (9 bytes)
<code>add(x,y,v0,v1,v3)</code>	adds values (first time it's a set)
<code>clip()</code>	clips the result to used bytes (not 255)

The following method also works; we might extend it on demand:

```

\startluacode
local v0 <const> = 0
local v1 <const> = 200 -- 63
local v2 <const> = 225 -- 127

function MP.bifurkation(bmp) -- or document.bifurkation
  local set = bmp.min
  for r = bmp.xmin, bmp.xmax, 0.002 do
    local old = 0.2
    for i = 0, 800 do
      local new = r * old * (1 - old)
      if i > 699 then
        set(r,old,v0,v1,v2)
      end
      old = new
    end
  end
end
\stopluacode

```

```

\startMPcode
draw lmt_domainmap [
  xmin      = 2.75,
  xmax      = 4.00,
  ymin      = 0,
  ymax      = 1,
  domainfunction = "bifurkation",
] ysize .40TextWidth;
\stopMPcode

```

Although ConTeXt is not really meant for manipulating graphics, the fact that we have MetaPost and plenty LuaMetaFun features alone are good reasons to provide some playground, if only because of the fun. So let's talk filters. A filter is run over the pixels in a bitmap and are specified by a table with odd numbers of columns and rows. You can install filters yourself. In order to avoid defining too many you can delay setting the center value (just set it to true) and apply a multiplier (factor).

```

\startluacode
metapost.registerfilter {
  name      = "sharpen:5",
  default   = 45,
  mapping   = {
    { -3, -2, -2, -2, -3 },
    { -2, -1, -1, -1, -2 },
    { -2, -1, true, -1, -2 },
    { -2, -1, -1, -1, -2 },
    { -3, -2, -2, -2, -3 },
  }
}
\stopluacode

```

\stopluacode

Next we show how to apply a filter. We have commented some parameters that demonstrate that you can also set the filter directly. The result can be seen in figure 24.6. Watch how we can apply multiple filters in sequence.

\startMPcode

```
triplet bm ; bm := loadbytemapfromfile(3, "mill.png") ;
```

```
lmt_filter [  
  source = 3,  
  target = 4,  
  % factor = 1,  
  % default = 45,  
  % filter = {  
  %   { -3, -2, -2, -2, -3 },  
  %   { -2, -1, -1, -1, -2 },  
  %   { -2, -1, true, -1, -2 },  
  %   { -2, -1, -1, -1, -2 },  
  %   { -3, -2, -2, -2, -3 }  
  % }  
  filter = "sharpen:5",  
  % filter = "sharpen:3",  
] ;
```

```
lmt_filter [  
  source = 3,  
  target = 5,  
  % filter = "gaussianblur",  
  % filter = "sharpen:5,gaussianblur",  
  filter = "gaussianblur,sharpen:5",  
] ;
```

```
draw bytemap 3 x sized 40mm ;  
draw bytemap 4 x sized 40mm xshifted 45mm ;  
draw bytemap 5 x sized 40mm xshifted 90mm ;
```

\stopMPcode



Figure 24.6 Sharpening (and blurring) a black and white png image.

Filters can be applied to color graphics too, in this case we mess with a jpeg image; of course, afterwards it is a png image. The result can be seen in figure 24.7. You need to play a bit with the default and factor.

\startMPcode

```
triplet bm ; bm := loadbytefromfile(5, "hacker.jpg") ;
```

```
lmt_filter [
  source = 5,
  target = 6,
  crop   = true, % can also be a number
  filter = "sharpen:3",
  factor = .5,
] ;
```

```
draw bytemap 5 xsize 60mm ;
draw bytemap 6 xsize 60mm xshifted 65mm ;
```

\stopMPcode

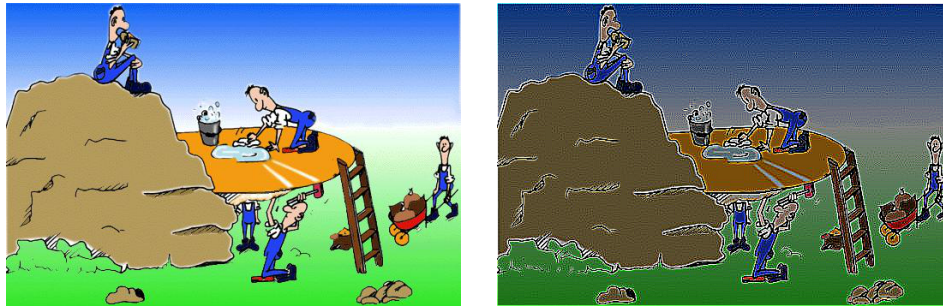

Figure 24.7 Sharpening a color jpeg image.

In `mlib-bmp.lmt` we predefine some filters:

```
sharpening    sharpen:5 sharpen:3:9 sharpen:3:5 unsharp:5
edge detection edge:3:8 edge:3:4 edge:horizontal edge:vertical sobel:horizontal sharr:hor-
                izontal sobel:vertical
embossing    emboss:3
blurring     boxblur gaussianblur:3 gaussianblur:5
```

You can find some information at Wikipedia: [Kernel_\(image_processing\)](#) or search for ‘image processing’ and ‘kernel’ to get such matrices and explanations.

25 Noise

This feature is work in progress and probably will be for a long time because we have to figure out nice parameters to drive this mechanism. An introduction can be found in `beyond-noisy` which is published in the fall TugBoat 2025 by Keith McKay and Hans Hagen. Some of what we tell below comes from that article.

With noise we mean so called Perlin noise. Among the many implementations of Perlin noise those of Stefan Gustavson at Linköping University makes most sense so we started from those. He has has written an excellent introduction on procedural methods that can be used for creating pseudo-random noise see <https://github.com/stegu/noiseisbeautiful/tree/main> that points to <https://liu.diva-portal.org/smash/get/diva2:1954979/FULLTEXT01.pdf>.

Although we started our experiments with coding in pure MetaPost eventually we ended up with using the available bytemap mechanism combined with a mix of engine features and Lua. This performs well enough to make it a runtime feature.

We show a few examples and assume that you read up on the matter, so we won't explain the parameters in detail. Just experiment with them and when you've found interesting patterns, share them on the mailing list; we might add some to a module.

Stefan improved the original Perlin a bit and called it Simplex. In addition he added features to feed back some details and apply angles. The later permit animations: for that you just generate a lot of MetaPost pages and feed those into a graphical editor to produce an animated gif or png.

```
\startMPcode
draw lmt_noise [
  bytemap      = 1,
  nx           = 200,
  ny           = 200,
  nz           = 1,
  iterations   = 1,
  frequency    = 0.05,
  minimum      = 0,
  maximum      = 255,
  method       = "perlin",
] xsize 5cm ;
\stopMPcode
```

Here we replaced `perlin` by `simplex` in the comparison. In figure 25.1 we compare these for one and two iterations. There are various parameters that we will shortly explain later:

<code>bytemap</code>	number	1
<code>nx</code>	number	10
<code>ny</code>	number	10
<code>nz</code>	number	1
<code>iterations</code>	number	1
<code>amplitude</code>	number	1.0
<code>frequency</code>	number	1.0

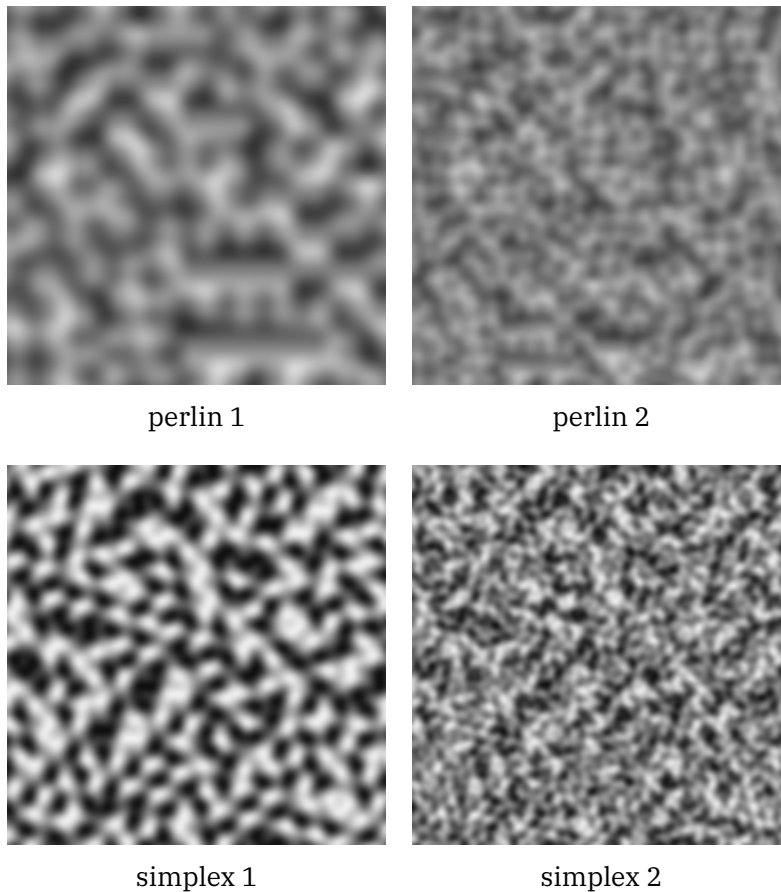

Figure 25.1 Perlin versus Simplex, one or two iterations.

```

persistence    number  0.5
lacunarity     number  2.0
minimum        number  0
maximum        number  255
preamble       string
colorcode      string
colorfunction  string
method         string   perlin
angle          number   0
initialize     boolean  true
filename       string
trace          false

```

A color function can be more advanced than just returning the normalized noise. Here we register one in the MP namespace. It works with one of the derivatives.

```

\startluacode
  local cos = math.cos
  local r = 256
  function MP.MyFunction(v,x,y,dx,dy)
    -- dx dy only available in last step
    return dy and cos(r-dy) * r
  end
\endluacode

```

```
\stopluacode
```

We will loop a few times to show the difference between iterations as demonstrated in figure 25.2.

```
\startMPcode
```

```
draw lmt_noise [
  bytemap      = 9,
  nx           = 200,
  ny           = 200,
  nz           = 1,
  iterations   = \recurselevel,
  frequency    = .05,
  amplitude    = 1,
  lacunarity   = 2.0,
  minimum      = 0,
  maximum      = 255,
  colorfunction = "MyFunction",
  method       = "detail",
] xsize .2TextWidth ;
```

```
\stopMPcode
```

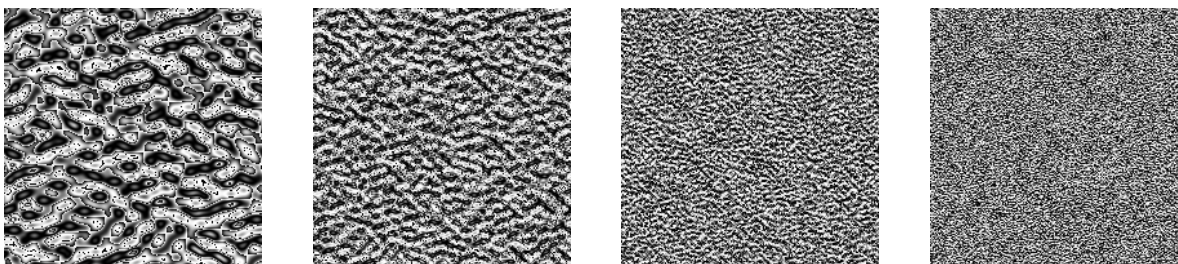

Figure 25.2 Detail noise generation with 2 upto 5 iterations.

The next (third) example is actually a nice one, as it combines several MetaFun features. For this we use a slightly adapted $\text{T}_{\text{E}}\text{X}$ logo because we want overlapping glyphs. A suitable font for this purpose is $\text{T}_{\text{E}}\text{X}$ Gyre Bonum.

```
\startluacode
```

```
function MP.MyFunction(v)
  return v/2, v, v/4
end
```

```
\stopluacode
```

An angle is used to calculate a sin and cosine multiplier so we get rotating effects. This example was used to check how well an animation will look as well as performance. Keep in mind that $\text{T}_{\text{E}}\text{X}$ is not really an animation machine, but these graphics can be used in that context. One can of course imagine changing page backgrounds in a document.

```
\startMPcode
```

```
draw
(
  lmt_outline [
    kind = "outline",
```

```

    text = "\strut \bf \MyTeX",
  ]
) xsize .25TextWidth
withpattern image (
  draw lmt_noise [
    bytemap      = 4,
    nx           = 500,
    ny           = 500,
    nz           = 3,
    iterations    = 1,
    frequency     = 0.01,
    amplitude     = 1,
    persistence   = 0.5,
    lacunarity    = 2.0,
    minimum       = 0,
    maximum       = 255,
    colorfunction = "MyFunction",
    method        = "angle",
    angle         = \recurselevel,
    % z           = sqrt(\recurselevel),
    % trace       = true,
  ] xsize .25TextWidth ;
) ;
\stopMPcode

```



Figure 25.3 Angled noise generated logos, to be used in a movie.

Controlled noise

The bytemap resolution is determined by `nx` and `ny` and the color depth `nz`. We need to explicitly mention a bytemap number because later on one might want to mess with it. When `filename` is given that file is loaded. It had better be a png image! When `initialize` is false an existing bytemap is used.

Possible methods are `perlin`, `simplex`, `detail` and `angle`. Internally these will be combined with an optional `angle` and `z` parameter to choose the right generator. The result is normalized to the range `minimum` and `maximum`.

The colorfunction has been show above and alternatively one can specify one or three return values in colorcode in which the preamble can define Lua shortcuts. We leave it at this, since there is more in the manuals.

That leaves the parameters that really control the noise. The general term of the wrapping generator is called ‘octave’ because multiple steps determine the result. A single step over x and y is defined as follows, we use Lua speak:

```
maxamplitude = 0
for i = 1, iterations do
    result      = simplex_noise_2(x * frequency, y * frequency)
    noise       = noise + amplitude * result
    maxamplitude = maxamplitude + amplitude
    amplitude   = amplitude * persistence
    frequency   = frequency * lacunarity
}
noise = noise / maxamplitude
noise = noise * (maximum - minimum) + (maximum + minimum)
noise = noise / 2
if noise > maximum then
    noise = maximum
elseif noise < minimum then
    noise = minimum
end
```

An explanation of these terms and additional terms can be found on the internet and in the literature relating to Perlin noise. They can explain this way better than we can. Here we just want to show what is involved. Believe us, the `simplex_noise_2` and similar functions do quite some computations so it is surprising that we can be as fast as we are!

To give you a taste of future usage, we show what the the example library `\useMPlibrary[noise]` provides: backgrounds.

Here is an example of a noisy frame around some text.

Figure 25.4 A noisy frame.

Figure 25.5 More colorful noise behind a quote (Zelensky).

Figure 25.5 is defined as follows. We use a predefined MetaPost graphic that we hook into the framed command.

```
\startuseMPgraphic{perlinbackground}{min,max}
    PerlinOverlay(1, 50, 255, 50, 3, "1-v, 0, v") ; % updated
\stopuseMPgraphic

\framed
```

```
[align=normal,
  frame=off,
  offset=4pt,
  foregroundstyle=bold,
  foregroundcolor=white,
  background=perlinbackground,
  rulethickness=4pt]
{\samplefile{zelensky}}
```

We use the opportunity to point out that we can fill a bytemap with noise but then optionally wipe out part of that bytemap, which is what we do when we just want an outline. As you can see, we have access from the MetaPost end to properties like `OverlayWidth` that relate to the background (an overlay). These are actually `vardef` macros that does an efficient Lua call to get some property.

```
def PerlinOverlay(expr kind, min, max, med, n, code) = % updated
  numeric resolution ; resolution := 5 ;
  numeric variation ; variation := 100 ;
  numeric nx ; nx := resolution * round(OverlayWidth +2OverlayOffset);
  numeric ny ; ny := resolution * round(OverlayHeight+2OverlayOffset);
  numeric lw ; lw := resolution * round(OverlayLineWidth);
  picture p ; p := image ( draw lmt_noise [
    bytemap = 3,
    nx      = nx,
    ny      = ny,
    nz      = n,
    method  = "detail",
    minimum = min,
    maximum = max,
    colorcode = code,
    z       = if variation <> 0 : uniformdeviate fi variation,
  ] ) ;
  if kind == 0 : % frame
    setbyte (lw,lw,nx-2lw,ny-2lw) of 3 to 255 ;
  elseif kind == 2 : % lighter inside
    setbyte (lw,lw,nx-2lw,ny-2lw) of 3 to (med,max) ;
  fi ;
  draw p xysized (OverlayWidth,OverlayHeight) ;
enddef ;
```

26 Interface

26.1 Macros

Because graphic solutions are always kind of personal or domain driven it makes not much sense to cook up very generic solutions. If you have a project where MetaPost can be of help, it also makes sense to spend some time on implementing the basics that you need. In that case you can just copy and tweak what is there. The easiest way to do that is to make a test file and use:

```
\startMPpage  
  % your code  
\stopMPpage
```

Often you don't need to write macros, and standard drawing commands will do the job, but when you find yourself repeating code, a wrapper might make sense. And this is why we have this key/value interface: it's easier to abstract your settings than to pass them as (expression or text) arguments to a macro, especially when there are many.

You can find many examples of the key/value driven user interface in the source files and these are actually not that hard to understand when you know a bit of MetaPost and the additional macros that come with MetaFun. In case you wonder about overhead: the performance of this mechanism is pretty good.

Although the parameter handler runs on top of the Lua interface, you don't need to use Lua unless you find that MetaPost can't do the job. I won't give examples of coding because I think that the source of MetaFun provides enough clues, especially the file `mp-lmtx.mpxl`. As the name suggests this is part of the ConTeXt version LMTX, which runs on top of LuaMetaTeX. I leave it open if I will backport this functionality to LuaTeX and therefore MkIV.

An excellent explanation of this interface can be found at:

<https://adityam.github.io/context-blog/post/new-metafun-interface/>

So (at least for now) here I can stick to just mentioning the currently stable interface macros:

<code>presetparameters</code>	<code>name [...]</code>	Assign default values to a category of parameters. Sometimes it makes sense not to set a default, because then you can check if a parameter has been set at all.
<code>applyparameters</code>	<code>name macro</code>	This prepares the parameter handler for the given category and calls the given macro when that is done.
<code>getparameters</code>	<code>name [...]</code>	The parameters given after the category name are set.

<code>hasparameter</code>	<code>names</code>	Returns true when a parameter is set, and false otherwise.
<code>hasoption</code>	<code>names options</code>	Returns true when there is overlap in given options, and false otherwise.

<code>getparameter</code>	<code>names</code>	Resolves the parameter with the given name. because a parameter itself can have a parameter list you can pass additional names to reach the final destination.
<code>getparameterdefault</code>	<code>names</code>	Resolves the parameter with the given name. because a parameter itself can have a parameter list you can pass additional names to reach the final destination. The last value is used when no parameter is found.
<code>getparametercount</code>	<code>names</code>	Returns the size if a list (array).
<code>getmaxparametercount</code>	<code>names</code>	Returns the size if a list (array) but descends into lists to find the largest size of a sublist.
<code>getparameterpath</code>	<code>names string boolean</code>	Returns the parameter as path. The optional string is one of <code>--</code> , <code>..</code> or <code>...</code> and the also optional boolean will force a closed path.
<code>getparameterpen</code>	<code>names</code>	Returns the parameter as pen (path).
<code>getparametertext</code>	<code>names boolean</code>	Returns the parameter as string. The boolean can be used to force prepending a so called <code>\strut</code> .
<code>pushparameters</code>	<code>category</code>	Pushed the given (sub) category onto the stack so that we don't need to give the category each time.
<code>popparameters</code>		Pops the current (sub) category from the stack.

Most commands accept a list of strings separated by one or more spaces, The resolved will then stepwise descend into the parameter tree. This means that a parameter itself can refer to a list. When a value is an array and the last name is a number, the value at the given index will be returned.

```
"category" "name" ... "name"
"category" "name" ... number
```

The `category` is not used when we have pushed a (sub) category which can save you some typing and also is more efficient. Of course than can mean that you need to store values at a higher level when you need them at a deeper level.

There are quite some extra helpers that relate to this mechanism, at the MetaPost end as well as at the Lua end. They aim for instance at efficiently dealing with paths and can be seen at work in the mentioned module.

There is one thing you should notice. While MetaPost has numeric, string, boolean and path variables that can be conveniently be passed to and from Lua, communicating colors is a bit of a hassle. This is because `rgb` and `cmyk` colors and gray scales use different types. For this reason it is strongly recommended to use strings that refer to predefined colors instead. This also enforces consistency with the \TeX end. As convenience you can define colors at the MetaFun end.

`\startMPcode`

```
definecolor [ name = "MyColor", r = .5, g = .25, b = .25 ]
fill fullsquare xyscaled (TextWidth,5mm) withcolor "MyColor" ;
```

`\stopMPcode`

26.2 Units

Many dimensions used at the \TeX end are also available in MetaFun. Examples are `TextWidth`, `EmHeight` and `StrutHeight`. In MkIV they are numeric variables that get set every graphic but in MkXL these are not numeric variables but (hidden) Lua calls so they can't be set at the MetaPost end; but they are injected as numeric quantities so you can efficiently them in calculations.

In MetaPost examples you often find `u` being used as unit, like:

```
u := 1cm ; draw (u,0) -- (u,u) -- (3u,0);
```

However, what if you want to set such a unit at the \TeX end? For this purpose we have a dedicated variable, which is demonstrated in the following examples. First we set a variable:

```
\uunit=1cm
\startMPcode
  definecolor [ name = "MyColor", r = .5, g = .25, b = .25 ]
  fill fullsquare xscaled (TextWidth,5mm) withcolor "MyColor" ;
\stopMPcode
```

and next we apply it:

```
\framed[offset=.2uu, strut=no]
  \bgroup
    \startMPcode
      fill fullcircle scaled (2uu) withcolor "darkblue" ;
      fill fullcircle scaled (8mm) withcolor "middlegray" ;
    \stopMPcode
  \egroup
```

The `\uunit` dimension register is hooked into \TeX 's unit parser as type `uu` (user unit). At the MetaPost end `uu` is effectively a Lua call that fetches the of the dimension from the \TeX end and presents it a a numeric.

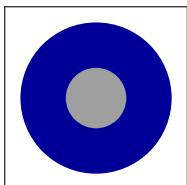

When we set

```
\uunit=5mm
```

The same code gives::



```
\framed[offset=.1uu,strut=no]
  \bgroup
    \startMPcode
      save uu ; numeric uu ; uu := 5mm ;
      fill fullcircle scaled (3uu) withcolor "darkred" ;
      fill fullcircle scaled (2uu) withcolor "middlegray" ;
    \stopMPcode
  \egroup
```

This demonstrates that we can overload uu but make sure to save it first so that later it is available again.

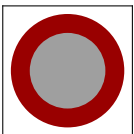

26.3 Paths from LUA

Passing paths to MetaPost using specific properties is sort of tricky because once the points are set, the solver will be applied. This translates curls, tensions and/or explicit control points into the final control points.

In the next example we show a few interfaces. Not all of that might be perfect yes but in most cases it works out.

```
\startluacode
  local shapes = { }
  shapes[1] = { {0,0}, {-1,-1}, {-1, 0}, {0,0}, "cycle" }
  shapes[2] = { {0,1}, { 1, 0}, { 1,-1}, {0,1}, "cycle" }
  shapes[3] = { {0,2}, { 2, 0}, { 2, 1}, {0,2}, "cycle" }
  shapes[4] = {
    {0,0}, {-1,-1}, {-1, 0}, {0,0}, "cycle", "append",
    {0,1}, { 1, 0}, { 1,-1}, {0,1}, "cycle", "append",
    {0,2}, { 2, 0}, { 2, 1}, {0,2}, "cycle", "append",
  }
  shapes[5] = {
    { path = shapes[1], append = true }, -- curled = true, tight = true
    { path = shapes[2], append = true }, -- curled = true, tight = true
    { path = shapes[3], append = true }, -- curled = true, tight = true
  }
  function mp.getshapepath(n)
    mp.inject.path(shapes[n])
  end
\stopluacode

\startMPcode
```

```

path p ;
p := lua.mp.getshapepath(1) scaled 1cm ;
draw p withpen pencircle scaled 2pt withcolor red ;
p := lua.mp.getshapepath(2) scaled 1cm ;
draw p withpen pencircle scaled 2pt withcolor blue ;
p := lua.mp.getshapepath(3) scaled 1cm ;
draw p withpen pencircle scaled 2pt withcolor green ;
p := lua.mp.getshapepath(4) scaled 1cm &&cycle ;
fill p withcolor 0.9 ;
draw p withpen pencircle scaled 1pt withcolor 0.7 ;
p := lua.mp.getshapepath(5) scaled 1cm ;
draw p withpen pencircle scaled .25pt withcolor 0.2 ;
\stopMPcode

```

Especially cycling and appending needs to be done precisely in order not to get redundant (or bad) points.

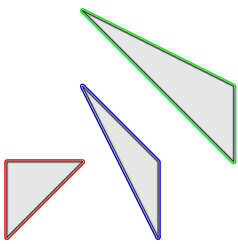

This combines the first three paths similar to the fourth and fifths. If you doubt what you get you can always show the path and look for `{begin}` and `{end}` indicators.

```

\startMPcode
path p ;
p := lua.mp.getshapepath(1) scaled 1cm &&
    lua.mp.getshapepath(2) scaled 1cm &&
    lua.mp.getshapepath(3) scaled 1cm ;
draw p withpen pencircle scaled 1pt withcolor 0.7 ;
% show(p);
\stopMPcode

```

We draw the result and see that they are decoupled indeed thanks to some `&&` magic:

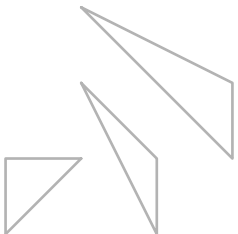

27 Performance

When we test new features in ConT_EXt LMTX, Mikael and I use his 290 page math book to check performance. In 2025 on an decent ChromeBook processing at some point took 7.4 seconds. When identifying a few bottlenecks, we could bring that down to 5.3 seconds. Actually the gain we got in the engine and ConT_EXt was measurable and made sense given specific (new) features we used, like `\parpasses`, but the biggest gain came from optimizing MetaPost usage.

Large images were already cached using the buffered content approach. This means that we only compile an (in this case) image when it has changed. Below we show an example. The images in the math book took much more time than these and some were huge, one even produced a 500 KB file and that was after we identified it as bottleneck and made is smaller.

So why is that, even with buffering, slowing down a run? The reason is that at some point we decided, when including pdf images, to check the content in more detail. We can remap color spaces, merge fonts and remove for instance tagging related crap. This actually slows down inclusion! So, on a huge MetaPost inclusion we loose time, but, when that one comes from ConT_EXt, it normally is a clean image, so we can do better indeed. Take these two examples:

```
% maybe load a style
\startMPPage
  picture p ; p := image (
    for i=1 step 2 until 100 :
      draw fullcircle scaled i ;
    endfor ;
  ) xsize 5cm ;
  setgroup p to unitsquare;
  draw p withpen pencircle scaled .4 ;
  % decoration, normally text
  fill fullcircle scaled 1cm
    withcolor white withtransparency (1,.5)
  ;
  addbackground withcolor "darkred";
\stopMPPage
```

and

```
% maybe load a style
\startMPPage
  draw image (
    for i=1 step 2 until 100 :
      draw fullcircle scaled i ;
    endfor ;
  ) xsize 5cm withpen pencircle scaled .4 ;
  setgroup currentpicture to unitsquare ;
  % decoration, normally text
  fill fullcircle scaled 1cm
    withcolor white withtransparency (1,.5)
  ;
```

```

    addbackground withcolor "darkgreen";
\stopMPpage

```

Now imagine an inclusion like this:

```

\startplacefigure
  [title={Caching images with grouping.},
   reference=performance:group]
  \hbox \bgroup
    \typesetbuffer[demo-1]%
    \quad
    \typesetbuffer[demo-2]%
  \egroup
\stopplacefigure

```

In both cases the graphic content in the page stream is analyzed, which takes time but we can disable that:

```

\startplacefigure
  [title={Caching images with grouping.},
   reference=performance:group]
  \hbox \bgroup
    \typesetbuffer[demo-1] [compact=]%
    \quad
    \typesetbuffer[demo-2] [compact=]%
  \egroup
\stopplacefigure

```

But then we do loose the merging of used font feature which gives smaller files at the cost of some extra analysis. Of course not all graphics have fonts but what if we have a decorated (with axis) demanding graphic?

To come back to the gain in performance. The still huge image could in the end be brought down to a 50 KB good looking bytemap, one we discuss in the chapter about bytemaps and domain graphics.

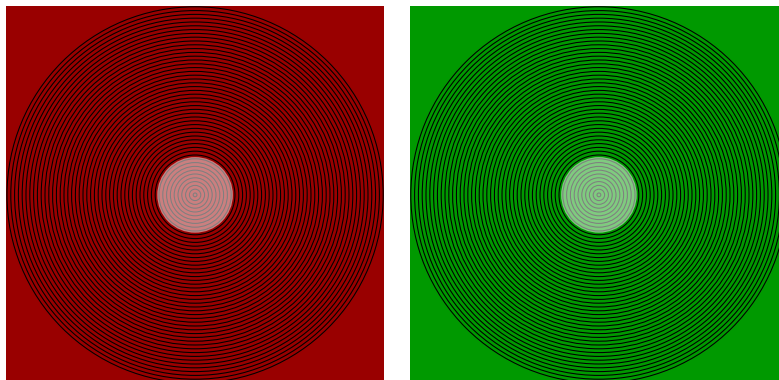

Figure 27.1 Caching images with grouping.

So, how can we actually gain performance on the two graphics in figure 27.1 and why do we show two variants of the same? The reason is that here we use `setgroup` to mark a picture as group. When marked as such, the inclusion is able to determine that the to be embedded pdf code can be passed as-is; there is no need to check it. The only drawback is that when you want to decorate the graphic with text, that

has to happen outside that group, but it is a small price to pay. The `unitsquare` is there because a path is expected, the `setgroup` is in terms of syntax comparable to a `setbounds` or `clip` operation.

28 Whatever

Here we will discuss a few additions that don't fit into a category and are unique to the LMTX version of MetaFun. Some could be in MkII and MkIV but we don't want to introduce compatibilities issues. We start with a set of new operators that relate to checking against some predefined constants.

internal	scaled	double	set value
eps	0.00049	0.00048999999999999998	0.0049
epsilon	0.00002	1.52587890625e-05	1/256/256
neglectable	0	9.9999999999999995e-07	0.000001
infinity	4095.99998	4095.9999800000001	4095.99998

We use these values to get around rounding issues, as in:

```
if a ~ b : do_this else : do_that fi ; % eps
if a ~~ b : do_this else : do_that fi ; % epsilon
if a ~~~ b : do_this else : do_that fi ; % neglectable
```

```
\startMPcode[instance=doublefun]
def ShowAbout text t =
  fill fullcircle scaled 20mm withcolor if 1 t 1 : red else : .5 fi ;
  fill fullcircle scaled 18mm withcolor if 1 t 1.1 : green else : .5 fi ;
  fill fullcircle scaled 16mm withcolor if 1 t 1.01 : blue else : .5 fi ;
  fill fullcircle scaled 14mm withcolor if 1 t 1.001 : white else : .5 fi ;
  fill fullcircle scaled 12mm withcolor if 1 t 1.0001 : red else : .5 fi ;
  fill fullcircle scaled 10mm withcolor if 1 t 1.00001 : green else : .5 fi ;
  fill fullcircle scaled 8mm withcolor if 1 t 1.000001 : blue else : .5 fi ;
  fill fullcircle scaled 6mm withcolor if 1 t 1.0000001 : white else : .5 fi ;
enddef ;
draw image (ShowAbout ~ ) ;
draw image (ShowAbout ~~ ) shifted (21mm,0) ;
draw image (ShowAbout ~~~) shifted (42mm,0) ;
\stopMPcode
```

We get this:

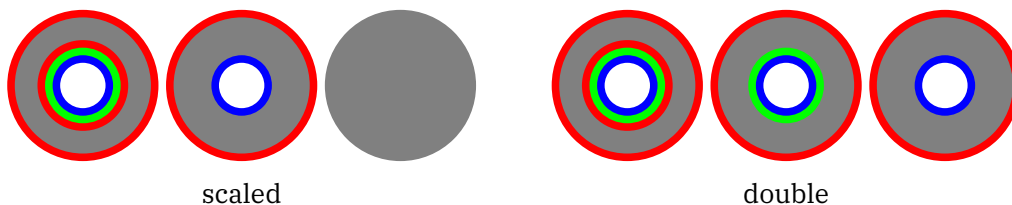

29 Oscillate

We have a command that makes text follow a shape but that one rotates the individual glyphs so that the bottom is parallel to the point it sits at. The feature shown here is different: here we adapt the shape for the glyph to the curve it sits on. A first example is shown in figure 29.1 where we have two texts on the same shape. We use DejaVu because that is a font where we don't get weird side effects due to for instance fancy serifs.

```
\startMPcode
  path shape ; shape := fullcircle xyscaled (500,400) rotated 45 ;
  draw shape withpen pencircle scaled 5 withcolor "darkgray" ;
  fill lmt_oscillated [
    text      = "\bf inside out ",
    path      = shape,
    yoffset   = 0,
  ] withcolor "darkgreen" ;
  fill lmt_oscillated [
    text      = "\bf up and down and ",
    path      = reverse shape,
    yoffset   = 40,
  ] withcolor "darkblue" ;
\stopMPcode
```



Figure 29.1

In order to keep the words separated we have added a space at the end. By default the baseline is on the curve but the `offset` parameter can change that. A shape can be closed or open, like in figure 29.2. In order to make a curve oscillate we need to add more points so here we show these points.

```
\startMPcode
  path shape ; shape := (
    (0,0) { up } .. (1,1) .. (2,0) .. (3,-1) .. { up } (4,0)
  ) xyscaled (500,200) ;
```

```

path p ; p := lmt_oscillated [
    text      = " \bf up and down and off we go ",
    path      = shape,
    % resolution = 5,
] ;
fill      p withcolor "darkgreen" ;
drawpoints p withcolor white ;
addbackground withcolor "darkred" ;
\stopMPcode

```



Figure 29.2

The text is typeset by T_EX so we get proper kerning and font features are applied, which is demonstrated in figure 29.3 where we use a Dutch snippet.

```

\startMPcode
path shape ; shape := (
    (0,0) { up } .. (1,1) .. (2,0) .. (3,-1) .. { up } (4,0)
) xyscaled (500,200) ;
draw shape withpen pencircle scaled 5 withcolor "darkgray" ;
path p ; p := lmt_oscillated [
    text      = " \bf effe flink fietsen op een fiets ",
    path      = shape,
    % resolution = 5,
] ;
fill p withcolor "darkgreen" ;
draw p withcolor "darkred" withpen pencircle scaled 5 ;
\stopMPcode

```



Figure 29.3

In figure 29.4 we apply a bit of kerning. Although this normally is not recommended here it makes sense, depending on the shape that is to be followed.

\definecharacterkerning

```
[mine1]  
[factor=0.05]
```

\startMPcode

```
path shape ; shape := reverse fullcircle xyscaled (500,400) rotated 45 ;  
draw shape withpen pencircle scaled 5 withcolor "middlegray" ;  
path p ; p := lmt_oscillated [  
  text      = "\setcharacterkerning[mine1]\bf\CONTEXT\ LMTX is FUN! "  
  path      = shape,  
  resolution = 10,  
] ;  
fill      p withcolor "darkyellow" ;  
drawpoints p withcolor "darkred" ;
```

\stopMPcode

A shape can best have curvature but straight lines do work. However, you should be prepared for strange effects. In figure 29.5 we have a rectangular path. The points are rather equally spaces. You can change the amount of points with a different resolution (15 is the default value) or you can set stepsize to some dimensions (say 2mm). We currently have four methods for calculating points with method = 4 being the default. Best use that default because the rest might go away and we only need it for historic reasons and documentation.

\definecharacterkerning

```
[mine2]  
[factor=0.1]
```

\startMPcode

```
path shape ; shape := reverse ( fullsquare smoothed .25 scaled 400 ) ;  
drawarrow shape withpen pencircle scaled 1 withcolor "darkgray" ;  
path p ; p := lmt_oscillated [  
  % text      = "\setcharacterkerning[mine2]\bf\CONTEXT\ LMTX is FUN! "  
  text      = "\setcharacterkerning[mine2]\bf\CONTEXT\ LMTX can be a lot  
    of FUN! "  
  path      = shape,  
  resolution = 10,  
] ;  
fill p withcolor darkyellow ;
```

\stopMPcode

The result (also) shown in figure 29.5 is not a bug but a feature. The oscillator just follows the rules. Getting the right way to oscillate actually took is some experimenting and we settled on the current approach. It's not the most efficient in terms of processing time but this feature is unlikely to be used in critical runs.

\startMPcode

```
path shape ; shape := (0,0) -- (250,100) -- (500,0) ;  
path p ; p := lmt_oscillated [  
  text      = "\setcharacterkerning[mine1]\bf CONTEXT!"  
  path      = shape,
```



Figure 29.4

```

    resolution = 10,
    method      = 4, % default (others might go away)
    stepsize    = 0, % default anyway
] ;
fill p withcolor "darkblue" ;
draw p withcolor "middlegray" withpen pencircle scaled 2.5 ;
\stopMPcode

```

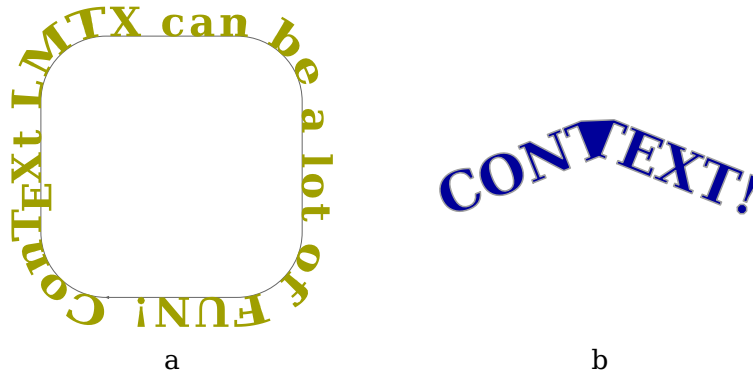

Figure 29.5

When you don't want to let this macro scale the text to fit the curve, you can set `scale` to zero (the default value is one). See figure 29.6 for an example.

```

\definecharacterkerning

```

```

  [mine]

```

```

  [factor=0.05]

```

```

\definecolor[ucolor][h=0057b7]

```

```

\definecolor[kcolor][h=ffd700]

```

```

\startMPcode

```

```

  def Test (expr s, r) =

```

```

    path p ; p := lmt_oscillated [

```

```

      text = "\setcharacterkerning[mine]\bf \samplefile {zelensky}",

```

```

      path = reverse fullcircle xyscaled (r,r),

```

```

      scale = s,

```

```

    ] ;

```

```

  draw reverse fullcircle xyscaled (r-20,r-20)

```

```

    withcolor "kcolor"

```

```

    withpen pencircle scaled 10;

```

```

  fill p

```

```

    withcolor "ucolor" ;

```

```

  enddef ;

```

```

  Test(0, 400) ; Test(1, 300) ; Test(2, 200) ;

```

```

\stopMPcode

```



Figure 29.6

30 Three dimensional surfaces

todo: maybe a few word how eye and such relate to positions

This is *not* a chapter that goes in depth into how to render 3D images in LuaMetaFun, because for that we have a dedicated manual; there are just too many commands and parameters involved. Here we just discuss some basics. The rendering is centered around meshes, These are just a list of triangles coded as triplets. Each of the three entries is an index into a points list. You can read more about meshes in the chapter on contour graphics (vectors). In most cases we only need a list of points (vertices) and can delegate dealing with triangle mapping to the engine, a probably somewhat uncommon approach but actually quite efficient; why bother with triangles when there is no need for.

\startluacode

```
metapost.registermesher("demo", function(specification)
  return {
    name      = "demo",
    id        = specification.id,
    vertices  = {
      { 1, 1, 1 }, { 3, 1, 2 },
      { 3, 3, 3 }, { 1, 3, 3 },
    },
    -- alternative 1:
    triangles = {
      { 1, 2, 3 }, { 1, 3, 4 },
    },
    -- alternative 2:
    meshtype = 7,
  }
end)
```

\stopluacode

Here we have a quad (four corners) split into two triangles. Two vertices are shared. Instead of providing the in this case trivial list of triangles you can specify a meshtype. An alterative way to define this is:

\startluacode

```
metapost.registermesher("demo", function(specification)
  return {
    name      = "demo",
    id        = specification.id,
    vertices  = {
      { 1, 1, 1 }, { 3, 1, 2 }, { 3, 3, 3 },
      { 1, 1, 1 }, { 3, 3, 3 }, { 1, 3, 3 },
    },
    -- alternative 1:
    triangles = {
      { 1, 2, 3 }, { 4, 5, 6 },
    },
    -- alternative 2:
```

```

        meshtype = 5,
    }
end)

```

\stopluacode

Before we move on, let's stress that this manually defining a mesh is not what this feature is about, it is just one of the ways to provide a mesh. More common are parametric and implicit surfaces, planes and overlapping areas (or curves) as well as external meshes generated by other programs. These are discussed in that other manual!

The following code will render this mesh. We set up a scene, define material and then register the internal mesh. Next we render so that we know the scenery which is needed in order to draw on top of what gets generated: a bytemap (see elsewhere for that that is about).

The collected meshes are put on a canvas in order and hidden surfaces are kept hidden, although with opacity enabled one can see them. In the end one gets a bytemap of given resolution with anti-aliasing with a quality driven by the supersampling.

\startMPcode

```

lmt_scene_start [
    bytemap      = 34,
    width        = 5cm,
    crop         = true,
    supersample  = 4,
    projection   = "perspective",
    eye          = (-2,-2,1),
    target       = (0,2,1),
    backgroundcolor = "darkblue", % (0,0,1)
] ;

lmt_scene_material [
    name        = "surface",
    diffuse     = "middlegray", % or resolvedcolor("middlegray") or (1,1,0)
] ;

lmt_scene_internal [
    id          = "one",
    name        = "demo",
    material    = "surface",
] ;

lmt_scene_render ;

pickup pencircle scaled 1 ;

draw lmt_scene_point(1,1,1) -- lmt_scene_point(3,3,3) withcolor "darkred" ;

pickup pencircle scaled 10 ;

drawdot lmt_scene_point(1,1,1) withcolor "darkred" ; % common
drawdot lmt_scene_point(3,1,2) withcolor "darkgreen" ;
drawdot lmt_scene_point(3,3,3) withcolor "darkred" ; % common

```

```

drawdot lmt_scene_point(1,3,3) withcolor "darkgreen" ;

setbounds currentpicture to lmt_scene_bounds ;

lmt_scene_stop ;
\stopMPcode

```

This setup results in the following rendering where the red points are the shared ones:

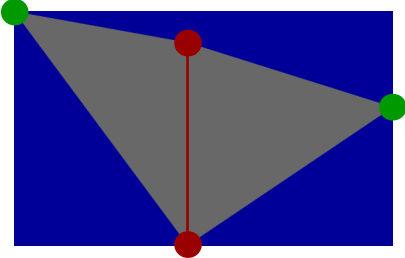

Drawing the points can be tricky because they get projected so the points in the mesh are not the points we get. The eye and target need to be set accordingly.

Constructing a mesh is normally done with some program and one can either produce Lua tables or vertex and mesh userdata objects. We just show these alternatives:

```

\startluacode
  metapost.registermesher("demo", function(specification)
    local vertices = vector.points.new(4)
    local triangles = vector.mesh.new(2)
    vertices(1,1,1)
    vertices(3,1,2)
    vertices(3,3,3)
    vertices(1,3,3)
    triangles(1,2,3)
    triangles(1,3,4)
    return {
      name      = "demo",
      id        = specification.id,
      vertices  = vertices,
      triangles = triangles,
    }
  end)
\stopluacode

```

Here we explicitly generate vertex and triangle data, but we could in this case have used a simple triangle setup:

```

\startluacode
  metapost.registermesher("demo", function(specification)
    local vertices = vector.points.new(4)
    local triangles = vector.mesh.new(2,7)
    vertices(1,1,1)
    vertices(3,1,2)
    vertices(3,3,3)

```

```

vertices(1,3,3)
return {
    name      = "demo",
    id        = specification.id,
    vertices  = vertices,
    triangles = triangles,
}
end)

```

\stopluacode

We even could have said:

\startluacode

```

metapost.registermesher("demo", function(specification)
    local vertices = vector.points.new(4)
    vertices(1,1,1)
    vertices(3,1,2)
    vertices(3,3,3)
    vertices(1,3,3)
    return {
        name      = "demo",
        id        = specification.id,
        vertices  = vertices,
        meshtype = 7,
    }
end)

```

\stopluacode

We have a few predefined meshes for users to play with and that can serve as example of how to create your own library. because specifications get passed, one can act accordingly, here for instance level is set to 2. The result is shown in figure 30.1.

\useMPLibrary[meshes-mengersponge]

\startMPcode

```

lmt_scene_start [
    bytemap      = 34,
    width        = 6cm,
    crop         = true,
    resolution   = 300,
    supersample  = 2,
    projection   = "perspective",
    eye          = (20,20,20),
    target       = (5,5,5),
    up           = (0,0,1),
    light        = (-1.2,-1,-2),
    intensity    = 1,
    %
    cache       = true,
] ;

```

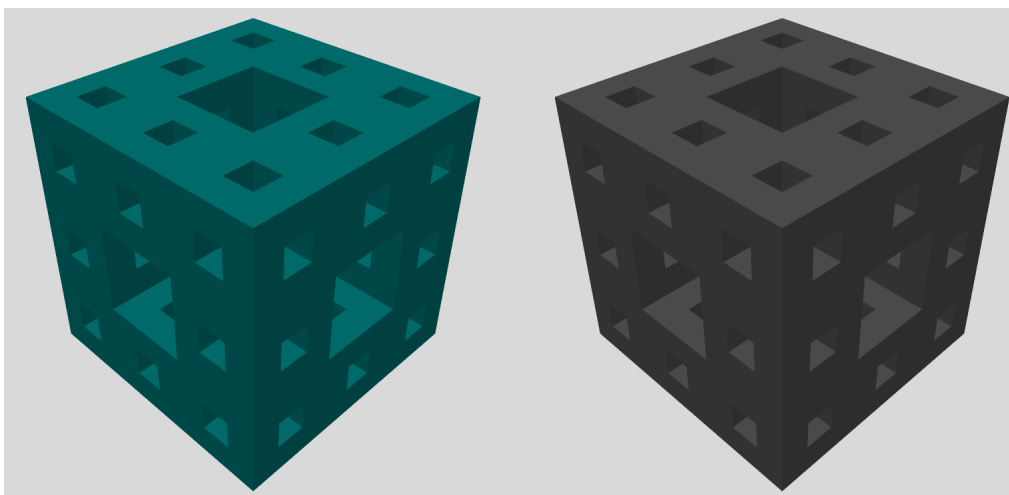

Figure 30.1 A level 2 Menger Sponge. The rightmost variant is a gray scale copy.

```

lmt_scene_material [
  name      = "surface",
  diffuse   = (0,0.5,.5),
  specular  = (.40,.40,.40),
  shininess = 40,
  % opacity = .15,
] ;

lmt_scene_internal [
  id        = "one",
  name      = "mengersponge",
  level     = 2,
  size     = 10,
  material  = "surface",
] ;

lmt_scene_stop ;

copybytemap 34 to 35 ; reducebytemap 35 ;

draw (bytemap 35 x sized 6cm) shifted (7cm,0) withbytemasked 255 ;
\stopMPcode

```

This is a nice test case for code generating llm's because as of mid 2026 most seem to get it wrong. It looks like they all base solutions in the same code harvested somewhere on the web, sometimes taking a bit of freedom to translate from whatever original language into Lua. The solution we used partially came from the ai feature in Google Chrome, given that one invites it to also add the *right* normals. These are simple experiments and errors are harmless because one does a visual check in the end.

In this example we also demonstrate that because the result is in a bytemap you can mess around with that afterwards. Watch how we define a mask so that the image can be put on a background with that color.

As an experiment added support for processing the intermediate result and this is how it's done:

```
\startluacode
```

```

local random = math.random

local function process(r,g,b)
  return
    5 * random(0,1) * r,
    5 * random(0,1) * g,
    5 * random(0,1) * b
end

metapost.registermeshupper {
  name      = "demo",
  version   = 1.000, -- makes caching unique
  skip      = true,  -- only when no background
  color     = true,  -- red, green, blue
  process   = process,
}
\stopluacode

```

In order for this work we need to add a process subtable to the scene specification. The result of this can be seen in figure 30.2.

```

\startMPcode
  lmt_scene_start [
    bytemap      = 34,
    width        = 6cm,
    crop         = true,
    resolution   = 300,
    supersample  = 2,
    projection    = "perspective",
    eye          = (20,20,20),
    target       = (5,5,5),
    up           = (0,0,1),
    light        = (-1.2,-1,-2),
    intensity    = 1,
    process      = "demo",
    % cache      = true,
  ] ;

  lmt_scene_material [
    name        = "surface",
    diffuse     = (.25,0,.25),
    specular    = (.40,.40,.40),
    shininess   = 40,
  ] ;

  lmt_scene_internal [
    id         = "one",
    name       = "mengersponge",
    level      = 2,
    size       = 10,
  ] ;
\stopMPcode

```

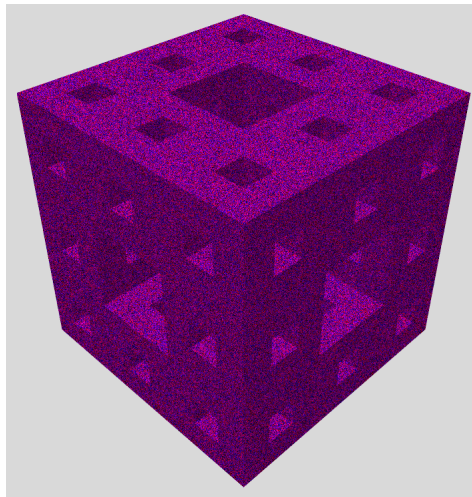

Figure 30.2 A Menger Sponge with the demo meshupper applied.

```

        material = "surface",
    ] ;

    lmt_scene_stop ;
\stopMPcode

```

The processors can act on properties of the graphic and the mechanism is such that we can let it evolve over time. Say we have the following, where we render at 300 dots per inch, calculate with twice that resolution as set by the supersample key, and make sure we use the right target size so that the bitmap doesn't need to be scaled afterwards.

```

\startMPcode
    lmt_scene_start [
        bytemap      = 34,
        width        = .5TextWidth,
        crop         = true,
        resolution   = 300,
        % resolution  = 150,
        supersample  = 2,
        projection   = "perspective",
        eye          = (20,20,20),
        target       = (5,5,5),
        up          = (0,0,1),
        light        = (-1.2,-1,-2),
        intensity    = 1,
        process      = "demo",
        % cache      = true,
    ] ;

    lmt_scene_material [
        name         = "surface",
        diffuse      = (.75,0.9,.55),
        specular     = (.40,.80,.30),
    ] ;
\stopMPcode

```

```

    shininess = 20,
    texture   = 1,
] ;

lmt_scene_parametric [
  id       = "sphere",
  x        = "sin(u)*cos(v)",
  y        = "sin(u)*sin(v)",
  z        = "cos(u)",
  xu       = "cos(u)*cos(v)",
  yu       = "cos(u)*sin(v)",
  zu       = "-sin(u)",
  xv       = "-sin(u)*sin(v)",
  yv       = "sin(u)*cos(v)",
  zv       = "0",
  umin     = 0,
  umax     = pi,
  vmin     = 0,
  vmax     = 2*pi,
  nu       = 100,
  nv       = 100,
  material = "surface",
] ;

lmt_scene_stop ;

```

\stopMPcode

A simple processor that just messes with the color is the following; we already saw a variant earlier. The result is shown figure 30.3.

\startluacode

```

local random = math.random

local function process(r,g,b)
  return
    1.5 * random(0,1) * r,
    1.5 * random(0,1) * g,
    1.5 * random(0,1) * b
end

metapost.registermeshupper {
  name       = "demo",
  version    = 1.000, -- makes caching unique
  skip       = true,  -- only when no background
  color      = true,  -- red, green, blue
  process    = process,
}

```

\stopluacode

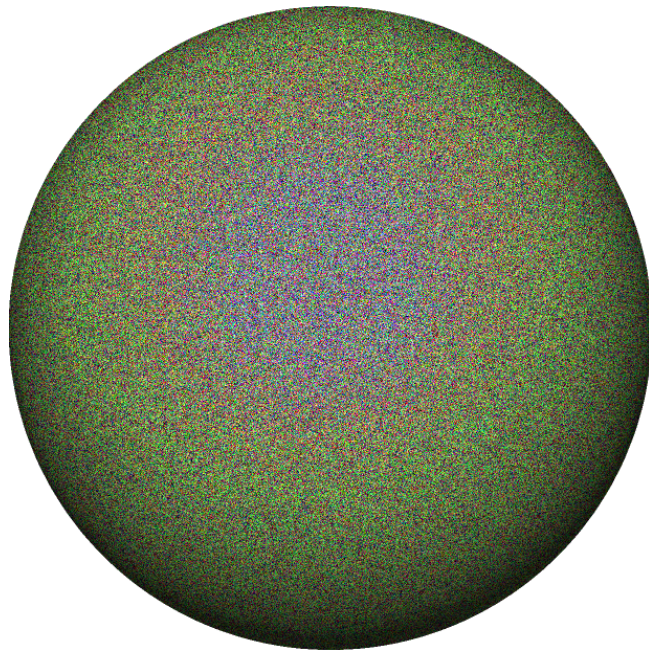

Figure 30.3 The result of demo process 1: manipulating colors.

You can also operate on the coordinates which is demonstrated in figure 30.4. These are the x , y and z values before projection.

```
\startluacode
  local sin = math.sin
  local cos = math.cos

  local function process(r,g,b,x,y,z,t)
    local a = 1 - sin(x)
    local b = 1 - cos(y)
    local c = cos(z) + sin(z)
    return a * r, b * g, c * b
  end

  metapost.registermeshupper {
    name      = "demo",
    version   = 1.000, -- makes caching unique
    skip      = true,  -- only when no background
    color     = true,  -- red, green, blue
    texture   = true,  -- t, x, y, z
    process   = process,
  }
\stopluacode
```

A third variant operates on the rows and columns of the ‘final’ image. Figure ?? shows what we get.

```
\startluacode
  local sin = math.sin
  local cos = math.cos

  local function process(row,col,r,g,b)
```

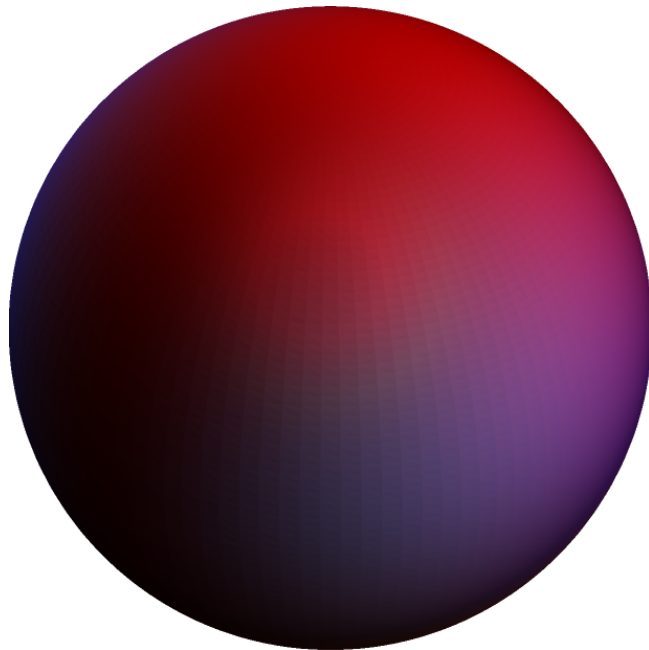

Figure 30.4 The result of demo process 2: manipulating colors using coordinates.

```

local f1 = sin(row/3) * cos(col/2)
local f2 = cos(col/3) * cos(row/2)
local f3 = cos(col/3) * sin(row/2)
return f1 * r, f2 * g, f3 * b
end

metapost.registermeshupper {
  name      = "demo",
  version  = 1.000, -- makes caching unique
  skip     = true,  -- only when no background
  slot     = true,  -- row, column
  color    = true,  -- red, green, blue
  process  = process,
}

```

\stopluacode

Currently you can ask for the following properties. When the corresponding key is true you will get these, in the following order:

slot	row column	positive integers
color	red green blue	positive numbers
normal	nx ny nz	numbers
texture	x y z t	numbers and integer

The texture might eventually become more advanced and the t specifier is just an integer that at some point can get more meaning. For instance for parametric curves we might also provide so called u and v coordinates combined with specific options triggered by this t.

We hope that this teaser will trigger your curiosity to read the more extensive manual on this topic. We anyway end with a warning: rendering these graphics can use a lot of memory but we try to clean up

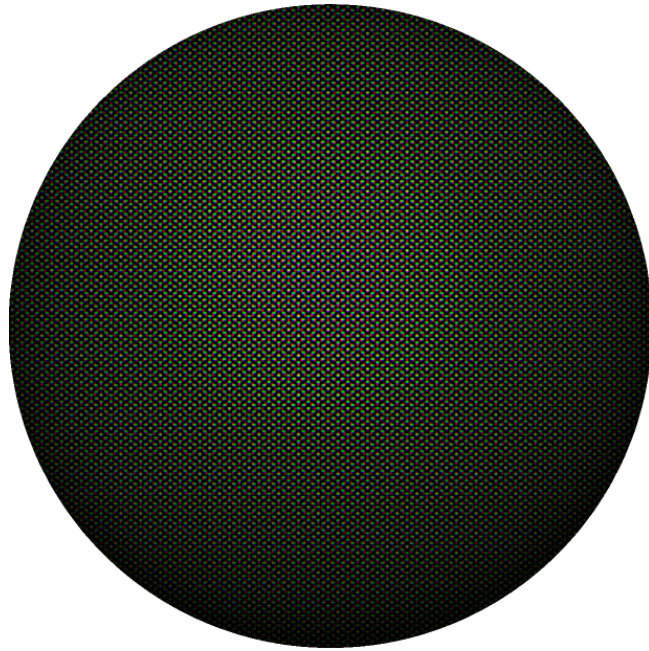

Figure 30.5 The result of demo process 3: manipulating colors using the final pixel positions.

when we can. The final results are bitmaps and therefore reasonable in size. You might cache the images using one of the various possibilities present in ConTeXt. The width, resolution and supersampling all add to the memory usage. A 6 cm wide figure, at 300 dots per inch and level 2 supersampling can end up between 500 MB and 1 GB which is still okay given what one asks for. The Menger Sponge in this chapter takes some 160 MB before the bytemap is created and has 1420 times 1420 pixels. We can dial down a bit by compiling the colors using floats instead of doubles but we keep the rest double so the gain is relatively small.

You can speed up a run by setting `cache` to `true`. The settings as well as bytemap are then saved and reused. When a setting changes, a new bytemap is generated. The runtime files can be removed with `context --purge`.

METAPOST syntax

The following syntax diagrams are similar to the diagrams in the MetaPost manual but also describe the additional primitives in the libraries that come with LuaT_EX and more important LuaMetaT_EX, because there the repertoire has been extended considerably. The → represents ‘means’ and the | symbol stands for ‘or’.

The diagrams describe the hard coded MetaPost syntax as well as most of the macros and variables defined in the plain MetaPost format that belongs to the core of the system. We also cover the extensions that LuaMetaT_EX provides. The diagrams also include most of the fundamental MetaFun and LuaMetaFun commands. We have omitted the MetaPost and MetaFont commands that make no sense any more or are irrelevant for common usage. Specific, more high level, commands are discussed in the MetaFun and LuaMetaFun manuals. There we also discuss preferred color and transparency directives. In LuaMetaFun the more configurable commands are in the `lmt_` namespace.

⟨atom⟩

- ⟨variable⟩ ⟨argument⟩
- | ⟨number or fraction⟩
- | ⟨internal variable⟩
- | (⟨expression⟩)
- | `begingroup` ⟨statement list⟩ ⟨expression⟩ `endgroup`
- | ⟨nullary op⟩
- | `btex` ⟨typesetting command⟩ `etex`
- | ⟨pseudo function⟩

⟨primary⟩

- ⟨atom⟩
- | (⟨numeric expression⟩ , ⟨numeric expression⟩)
- | (⟨numeric expression⟩ , ⟨numeric expression⟩ , ⟨numeric expression⟩)
- | (⟨numeric expression⟩ , ⟨numeric expression⟩ , ⟨numeric expression⟩ , ⟨numeric expression⟩)
- | ⟨of operator⟩ ⟨expression⟩ `of` ⟨primary⟩
- | ⟨numeric expression⟩ ⟨expression⟩ `along` ⟨path expression⟩
- | ⟨numeric expression⟩ ⟨expression⟩ `on` ⟨path expression⟩
- | ⟨unary op⟩ ⟨primary⟩
- | `str` ⟨suffix⟩
- | `z` ⟨suffix⟩
- | ⟨numeric atom⟩ [⟨expression⟩ , ⟨expression⟩]
- | ⟨scalar multiplication op⟩ ⟨primary⟩
- | ⟨color expression⟩ `shadedinto` ⟨color expression⟩
- | ⟨picture expression⟩ `asgroup` ⟨string expression⟩
- | ⟨picture expression⟩ `onlayer` ⟨string expression⟩
- | ⟨path operator⟩ ⟨primary⟩

⟨secondary⟩

- ⟨primary⟩
- | ⟨secondary⟩ ⟨primary binop⟩ ⟨primary⟩
- | ⟨secondary⟩ ⟨transformer⟩

⟨tertiary⟩

- ⟨secondary⟩
- | ⟨tertiary⟩ ⟨secondary binop⟩ ⟨secondary⟩

<subexpression>
 → <tertiary>
 | <path expression> <path join> <path knot>

<expression>
 → <subexpression>
 | <expression> <tertiary binop> <tertiary>
 | <path subexpression> <direction specifier>
 | <path subexpression> <continuation specifier>
 | <path subexpression> <path join> <cycle specifier>

<string expression>
 → (" , ') <string> (" , ')

<cycle specifier>
 → cycle | nocycle | recycle

<continuation specifier>
 → xabsolute | yabsolute | xyabsolute
 | xrelative | yrelative | xrelative

<path knot>
 → <tertiary>

<path join>
 → -- | ---
 | <direction specifier> <basic path join> <direction specifier>

<direction specifier>
 → <empty>
 | { curl <numeric expression> }
 | { <pair expression> }
 | { <numeric expression> , <numeric expression> }

<basic path join>
 → ..
 | ...
 | .. <tension> ..
 | .. <controls> ..
 | .. firstcontrol <pair primary>
 | .. secondcontrol <pair primary>

<tension>
 → tension <numeric primary>
 | tension atleast <numeric primary>
 | tension <numeric primary> and <numeric primary>

<controls>
 → controls <pair primary>
 | controls <pair primary> and <pair primary>

<argument>
 → <symbolic token>

<number or fraction>
 → <number> / <number>

| (number) ‘not followed by’ / (number)

(scalar multiplication op)

→ + | -

| (number or fraction) ‘not followed by’ (add op) (number)

(transformer)

→ rotated (numeric primary)

| scaled (numeric primary) | xscaled (numeric primary) | yscaled (numeric primary)

| zscaled (pair primary) | xyscaled (numeric or pair primary)

| shifted (pair primary) | xshifted (numeric primary) | yshifted (numeric primary)

| slanted (numeric primary)

| transformed (transform primary)

| **reflectedabout** ((pair expression) , (pair expression))

| **mirroredabout** (pair expression)

| **rotatedaround** ((pair expression) , (numeric expression))

| **x sized** (numeric primary) | **y sized** (numeric primary) | **xy sized** (numeric or pair primary)

| **blownup** (numeric or pair primary)

| **enlarged** (numeric or pair primary)

| **leftenlarged** (numeric primary) | **llenlarged** (numeric primary) | **llmoved** (numeric primary)

| **rightenlarged** (numeric primary) | **lrenlarged** (numeric primary) | **lrmoved** (numeric primary)

| **topenlarged** (numeric primary) | **urenlarged** (numeric primary) | **urmoved** (numeric primary)

| **bottomenlarged** (numeric primary) | **ulenlarged** (numeric primary) | **ulmoved** (numeric primary)

| **x stretched** (numeric primary) | **ystretched** (numeric primary) | **stretched** (numeric or pair primary)

| **shortened** (numeric or pair primary)

| **enlonged** (numeric or pair primary)

| **crossed** (numeric primary)

| **paralleled** (numeric primary)

| **enveloped** (numeric primary)

| **scrutinized** (numeric primary)

| **recycled** (numeric primary)

| **smoothcornered** (numeric primary)

| **maxsmoothcornered** (numeric primary)

| **paralleled** (numeric primary)

| **randomized** (numeric or pair or color primary)

| **randomizedcontrols** (numeric or pair)

| **randomrotatedcontrols** (numeric or pair)

| **snapped** (numeric or pair primary)

| **cornered** (numeric or pair)

| **peepholed** (path expression)

| **smoothed** (numeric or pair)

| **squeezed** (numeric or pair primary)

| **superellipsed** (numeric primary)

| **randomshifted** (numeric or pair primary)

| **uncolored** (color primary)

| **softened** (numeric or color primary)

| **asgroup** (string primary)

| **gobbled** (primary)

| **insideof** (path expression)

| **outsideof** (path expression)

| **crossingunder** (path expression)

| **closedcurve** (path or pair expression)

- | `closedlines` (path or pair expression)
- | `bytemapscaled` (numeric primary)

<numeric or pair primary>

- <numeric primary>
- | <pair primary>

<numeric or pair or color primary>

- <numeric primary>
- | <pair primary>
- | <color primary>

<numeric or color primary>

- <numeric primary>
- | <color primary>

<nullary op>

- `false` | `true`
- | `normaldeviate`
- | `nullpen` | `nullpicture` | `pencircle`
- | `pathpoint` | `pathpostcontrol` | `pathprecontrol` | `pathxpart` | `pathypart`
- | `pathfirst` | `pathlast` | `pathindex` | `pathlastindex` | `pathlength` | `pathstate`
- | `pathdirection` | `pathunitdirection`
- | `lastx` | `lasty` | `lastxy` | `previousx` | `previousy` | `previousxy`
- | `whatever`
- | `readstring`
- | `mpversion`

<unary op>

- <type>
- | `ASCII`
- | `byte`
- | `acos` | `acosh` | `acosd` | `asin` | `asinh` | `asind` | `atan` | `atand` | `cosd`
- | `cos` | `cotd` | `cosh` | `sin` | `sind` | `sinh` | `tan` | `tand` | `cot`
- | `inverse` | `inv` | `invcos` | `invsin` | `invtan`
- | `sqr` | `sqrt` | `pow` | `exp` | `mexp` | `mlog` | `ln` | `log` | `uniformdeviate`
- | `abs` | `odd` | `floor` | `ceiling` | `round`
- | `dir` | `angle` | `length` | `nolength` | `arclength` | `segments`
- | `bbox` | `bbwidth` | `bbheight`
- | `bot` | `lft` | `rt` | `top` | `center`
- | `colordecimals` | `decimal` | `ddecimal` | `dddecimal` | `ddddecimal` | `condition`
- | `tostring` | `topair` | `quote` | `quotation`
- | `boundingbox` | `outerboundingbox` | `innerboundingbox` | `bbox`
- | `colorpart` | `fontpart` | `pathpart` | `penpart` | `textpart` | `dashpart`
- | `redpart` | `greenpart` | `bluepart` | `greypart` | `graypart`
- | `cyanpart` | `magentapart` | `yellowpart` | `blackpart`
- | `postscriptpart` | `prescriptpart` | `stackingpart`
- | `clipped` | `bounded` | `stroked` | `filled`
- | `punked` | `paralleled` | `convexed`
- | `leftboundary` | `rightboundary` | `topboundary` | `bottomboundary`
- | `xpart` | `xypart` | `xypart` | `ypart` | `yxpart` | `yypart`
- | `zpart` | `wpart`
- | `xrange` | `yrange`
- | `oct` | `hex`

| `colortype`
 | `grayed` | `greyed`
 | `llcorner` | `lrcorner` | `ulcorner` | `urcorner` | `corners`
 | `not` | `known` | `unknown`
 | `blackcolor` | `whitecolor` | `colormodel`
 | `char` | `fontsize`
 | `cycle` | `nocycle` | `recycle`
 | `reverse` | `uncontrolled` | `prunesingularities`
 | `makepath` | `makepen` | `makenep`
 | `unitvector`
 | `turningnumber`
 | `circularpath` | `squarepath` | `linearpath`
 | `deltapoint` | `deltapostscontrol` | `deltaprecontrol` | `deltadirection` | `deltaunitdirection` | `deltapointarclength`
 | `centerof` | `centerofmass` | `singularity` | `counterclockwise`
 | `knownnormalize` | `knownnorm`
 | `xnormalized` | `ynormalized` | `xynormalized`
 | `area`
 | `inverted`
 | `simplified`
 | `unspiked`
 | `laddered`
 | `mirrored`
 | `curved`
 | `smoothened`

<type>

→ `boolean` | `numeric` | `pair` | `path`
 | `pen` | `nep` | `picture` | `string` | `transform`
 | `color` | `cmykcolor` | `greycolor` | `graycolor` | `rgbcolor`
 | `property` | `transparency`

<primary binop>

→ `*` | `^` | `/` | `**` | `and`
 | `dotprod` | `crossprod` | `div` | `infont` | `mod`

<secondary binop>

→ `+` | `-` | `++` | `+++` | `or`
 | `intersectionpoint` | `intersectiontimes` | `intersectiontimeslist`
 | `knowncrossprod` | `knowndiv` | `knowndotprod` | `knowndotmod`

<tertiary binop>

→ `&` | `&&` | `&&&` | `&&&&`
 | `<` | `<=` | `<>` | `=` | `>` | `>=`
 | `~` | `~~` | `~~~`
 | `cutafter` | `cutafterfirst` | `cutafterlast`
 | `cutbefore` | `cutbeforefirst` | `cutbeforelast`
 | `cutends` | `softjoin`

<of operator>

→ `arctime` | `arcpoint` | `arcpointlist`
 | `direction` | `directiontime` | `directionpoint`
 | `penoffset` | `point` | `segment`
 | `postcontrol` | `precontrol` | `subpath` | `subarclength` | `substring`
 | `boundingpath` | `enveloppe`

| bytefound | bytemapbounds | bytepath | bytevalue

⟨path operator⟩

→ firstpoint | firstprecontrol | firstpostcontrol
| firstdirection | firstunitdirection
| lastpoint | lastprecontrol | lastpostcontrol | lastdirection | lastunitdirection

⟨variable⟩

→ ⟨predefined numeric variable⟩
| ⟨predefined path variable⟩
| ⟨predefined picture variable⟩
| ⟨predefined transform variable⟩
| ⟨predefined pair variable⟩
| ⟨predefined pen variable⟩
| ⟨predefined string variable⟩
| ⟨predefined dashpattern⟩
| ⟨predefined rgbcolor variable⟩
| ⟨predefined macro⟩
| ⟨tag⟩ ⟨suffix⟩

⟨predefined numeric variable⟩

→ **nothing yet**

⟨predefined picture variable⟩

→ **blankpicture**
| **currentpicture**

⟨predefined transform variable⟩

→ **identity** | **currenttransform**

⟨predefined path variable⟩

→ **originpath**
| **fullcircle** | **fullsquare** | **fulldiamond** | **fulltriangle**
| **unitcircle** | **unitsquare** | **unitdiamond** | **unittriangle**
| **halfcircle** | **quartercircle**
| **llcircle** | **lrcircle** | **urcircle** | **ulcircle**
| **bcircle** | **tcircle** | **lcircle** | **rcircle**
| **triangle**
| **righttriangle** | **uptriangle** | **lefttriangle** | **downtriangle**
| **lltriangle** | **lrtriangle** | **urtriangle** | **ultriangle**
| **cuttings**

⟨predefined pair variable⟩

→ **right** | **up** | **left** | **down**
→ **shadedright** | **shadedup** | **shadedleft** | **shadeddown**

⟨predefined pen variable⟩

→ **pensquare** | **penrazor** | **penspec**
| **currentpen**

⟨predefined string variable⟩

→ **EOF**
| **CRLF** | **crlf**
| **DQUOTE** | **dquote** | **ditto**
| **SPACE** | **space**

- | PERCENT | percent
- | defaultfont
- | extra_beginfig | extra_endfig
- | pathconnectors

<predefined dashpattern>

- evenly | oddly | withdots

<predefined rgbcolor variable>

- red | green | blue | white
- | cyan | magenta | yellow | black
- | background
- | basiccolors

<predefined macro>

- shipit | bye
- | resetdrawoptions
- | visualizepaths | naturalizepaths

<suffix>

- <empty>
- | <suffix> <subscript>
- | <suffix> <tag>
- | <suffix parameter>

<subscript>

- <number>
- | [<numeric expression>]

<internal variable>

- aangle | alength
- | bboxmargin | labeloffset
- | charcode | charht | chardp | charwd | charic
- | defaultcolormodel | defaultzeroangle | defaultpen | defaultscale
- | linecap | linejoin | miterlimit
- | intersectionprecision | jointolerance
- | lessdigits | numberprecision | numbersystem
- | showstopping pausing
- | overloadmode | jobname
- | tracingoutput | tracingcapsules | tracingchoices | tracingcommands | tracingequations
- | tracinglostchars | tracingmacros | tracingonline | tracingrestores | tracingspecs
- | tracingstats | tracingtitles | tracingdependencies
- | truecorners | warningcheck
- | dotlabeldiam
- | day | month | year | hour | minute | time
- | mm | pt | dd | bp | cm | pc | cc | in
- | butt | rounded | squared | mitered | beveled
- | pi | radian | eps | epsilon
- | nocolormodel | greycolormodel | graycolormodel | rgbcolormodel | cmykcolormodel
- | texttextoffset
- | maxdimensions
- | pruneoptions
- | restoreclipcolor
- | textscriptmode

- | `textscriptmode`
- | `stacking`
- | `infinity`
- | `charscale`
- | `metapostversion`
- | `normaltransparent` | `multiplytransparent` | `screentransparent` | `overlaytransparent`
- | `softlighttransparent` | `hardlighttransparent` | `colordodgettransparent` | `colorburntransparent`
- | `darkenttransparent` | `lightenttransparent` | `differencetransparent` | `exclusiontransparent`
- | `huetransparent` | `saturationtransparent` | `colortransparent` | `luminositytransparent`
- | `<symbolic token defined by newinternal >`
- | `ahangle` | `ahlength`
- | `bboxmargin`
- | `pen_bot` | `pen_top` | `pen_lft` | `pen_rt`
- | `join_radius`
- | `crossingscale` | `crossingoption`

`<pseudo function >`

- `min` (`<expression list >`) | `max` (`<expression list >`)
- | `incr` (`<numeric variable >`) | `decr` (`<numeric variable >`)
- | `dashpattern` (`<on/off list >`)
- | `interpath` (`<numeric expression >` , `<path expression >` , `<path expression >`)
- | `interpolated` (`<numeric expression >` , `<path expression >` , `<path expression >`)
- | `buildcycle` (`<path expression list >`)
- | `thelabel` (`<label suffix >`) (`<expression >` , `<pair expression >`)
- | `thefree-label` (`<expression >` , `<pair expression >` , `<pair expression >`)
- | `anglebetween` (`<path expression >` , `<path expression >` , `<expression >`)
- | `flex` (`<text >`)
- | `hide` (`<text >`)
- | `gobble` `<primary >`
- | `clearit`
- | `clearpen`
- | `clearxy`
- | `pointarrow` (`<path expression >` , `<numeric or pair primary >` , `<numeric expression >`)
- | `centerarrow` (`<path expression >` , `<numeric or pair primary >` , `<numeric expression >`)
- | `leftarrow` (`<path expression >` , `<numeric or pair primary >` , `<numeric expression >`)
- | `rightarrow` (`<path expression >` , `<numeric or pair primary >` , `<numeric expression >`)
- | `paired` (`<numeric or pair >`) | `tripled` (`<numeric or color >`)
- | `remappedcolor` (`<color expression >`)
- | `superellipse` (`<numeric primary >` , `<numeric primary >` , `<numeric primary >` , `numeric primary` , `numeric primary`)
- | `roundedsquare` (`<numeric primary >` , `<numeric primary >` , `<numeric primary >`)
- | `roundedsquarexy` (`<numeric primary >` , `<numeric primary >` , `<numeric primary >`)
- | `tensecircle` (`<numeric primary >` , `<numeric primary >` , `<numeric primary >` , `<numeric primary >`)
- | `tensepath` `<path primary >`
- | `sortedpath` `<path primary >`
- | `uniquepath` `<path primary >`
- | `(constructed)function` (`<string expression >`) (`<string primary >` , `<string primary >` , `<numeric primary >` , `<numeric primary >` , `<numeric primary >`)
- | `straightfunction` (`<string primary >` , `<string primary >` , `<numeric primary >` , `<numeric primary >` , `<numeric primary >`)
- | `curvedfunction` (`<string primary >` , `<string primary >` , `<numeric primary >` , `<numeric primary >` , `<numeric primary >`)
- | `constructedpairs` (`<string expression >`) (`<pair array >`)

- | **straightpairs** (<pair array>)
- | **curvedpairs** (<pair array>)
- | **constructedpath** (<string expression>) (<text>)
- | **straightpath** (<text>)
- | **curvedpath** (<text>)
- | **epsed** <numeric primary>
- | **arrowhead** <path primary>
- | **arrowpath** <path primary>
- | **midarrowhead** <path primary>
- | **infinite** <path primary>
- | **tolist** (<pair array>) (<text>)
- | **topath** (<pair array>) (<text>)
- | **tocycle** (<pair array>) (<text>)
- | **pencilled** (<path expression>) (<pen expression>)

<color expression>

- <basic color expression>
- | <string primary>
- | **namedcolor** (<string primary>)
- | **spotcolor** (<string primary> , <basic color expression>)
- | **multitonecolor** (<string primary> , <basic color expression list>)

<basic color expression>

- <rgb color expression>
- | <cmyk color expression>
- | <gray color expression>
- | <string expression>

<basic color expression list>

- <basic color expression>
- | <basic color expression list> , <basic color expression>

<rgb color expression>

- < () <numeric primary> , <numeric primary> , <numeric primary> <) >

<cmyk color expression>

- < () <numeric primary> , <numeric primary> , <numeric primary> , <numeric primary> <) >

<gray color expression>

- < () <numeric primary> <) >
- | <numeric primary>

<path expression list>

- <path expression>
- | <path expression list> , <path expression>

<on/off list>

- <on/off list> <on/off clause>
- | <on/off clause>

<on/off clause>

- **on** <numeric tertiary>
- | **off** <numeric tertiary>

<boolean expression> → <expression>

<cmyk expression> → <expression>

<color expression> → <expression>
 <numeric atom> → <atom>
 <numeric expression> → <expression>
 <numeric primary> → <primary>
 <numeric tertiary> → <tertiary>
 <numeric variable> → <variable> | <internal variable>
 <pair expression> → <expression>
 <pair primary> → <primary>
 <path expression> → <expression>
 <path subexpression> → <subexpression>
 <pen expression> → <expression>
 <picture expression> → <expression>
 <picture variable> → <variable>
 <rgb expression> → <expression>
 <string expression> → <expression>
 <suffix parameter> → <parameter>
 <transform primary> → <primary>

<program>
 → <statement list> end

<statement list>
 → <empty>
 | <statement list> ; <statement>

<statement>
 → <empty>
 | <equation>
 | <assignment>
 | <declaration>
 | <macro definition>
 | <compound>
 | <pseudo procedure>
 | <command>

<compound>
 → `begingroup` <statement list> `endgroup`
 | `beginfig` (<numeric expression>) ; <statement list> <: > `endfig`
 | `beginglyph` (<glyph property list>) ; <statement list> <: > `endglyph`
 | `image builder` (<statement list>)

<image builder>
 → `image` | `decorated` | `redecorated` | `undecorated`

<glyph property list>
 → <numeric expression> , <numeric expression> , <numeric expression> , <numeric expression>

<equation>
 → <expression> = <right-hand side>

<assignment>
 → <variable> := <right-hand side>
 | <internal variable> := <right-hand side>

<right-and side>

→ `<expression>`
 | `<equation>`
 | `<assignment>`

`<declaration>`
 → `<type>` `<declaration list>`

`<declaration list>`
 → `<generic variable>`
 | `<declaration list>` , `<generic variable>`

`<generic variable>`
 → `<symbolic token>` `<generic suffix>`

`<generic suffix>`
 → `<empty>`
 | `<generic suffix>` `<tag>`
 | `<generic suffix>` `[]`

`<macro definition>`
 → `<macro heading>` = `<replacement text>` `enddef`

`<macro heading>`
 → `def` `<symbolic token>` `<delimited part>` `<undelimited part>`
 | `vardef` `<generic variable>` `<delimited part>` `<undelimited part>`
 | `vardef` `<generic variable>` `@#` `<delimited part>` `<undelimited part>`
 | `<binary def>` `<parameter>` `<symbolic token>` `<parameter>`

`<delimited part>`
 → `<empty>`
 | `<delimited part>` (`<parameter type>` `<parameter tokens>`)

`<parameter type>`
 → `expr`
 | `suffix`
 | `text`

`<parameter tokens>`
 → `<parameter>`
 | `<parameter tokens>` , `<parameter>`

`<parameter>`
 → `<symbolic token>`

`<undelimited part>`
 → `<empty>`
 | `<parameter type>` `<parameter>`
 | `<precedence level>` `<parameter>`
 | `expr` `<parameter>` `of` `<parameter>`

`<precedence level>`
 → `primary`
 | `secondary`
 | `tertiary`

`<binary def>`
 → `<primarydef>`

| <secondarydef>
| <tertiarydef>

<pseudo procedure>

→ **drawoptions** (<option list>)
| **label** <label suffix> (<expression> , <pair expression>)
| **thelabel** <label suffix> (<expression> , <pair expression>)
| **dotlabel** <label suffix> (<expression> , <pair expression>)
| **makelabel** <makelabel>
| **labels** <label suffix> (<point number list>)
| **dotlabels** <label suffix> (<point number list>)
| **texttext** <label suffix> (<expression>)
| **infotext** <label suffix> (<expression> , <numeric expression>)
| **thetexttext** <label suffix> (<expression> , <pair expression>)
| **rawtexttext** (<expression>)
| **verbatim** <string expression>
| **freelabel** (<expression> , <pair expression> , <pair expression>)
| **freedotlabel** (<expression> , <pair expression> , <pair expression>)
| **remapcolor** (<color expression> , <color expression>)
| **resetcolormap**
| **recolor** <picture expression>
| **bitmapimage** (<numeric primary> , <numeric primary> , <string primary>)
| **pushboundingbox** | **popboundingbox**
| **pushcurrentpicture** | **popcurrentpicture**
| **externalfigure** <string expression> <transformer>
| **loadfigure** <string expression> **number** <numeric expression> <transformer>
| **properties**
| **anchored** <label suffix> (<expression> , <pair expression>)

<point number list>

→ <suffix> | <point number list> , <suffix>

<label suffix>

→ <empty>
| **lft** | **rt** | **top** | **bot** | **ulft** | **urt** | **llft** | **lrt** | **raw** | **origin**

<command>

→ **clip** <picture variable> to <path expression>
| **interim** <internal variable> := <right-hand side>
| **let** <symbolic token> = <symbolic token>
| **pickup** <expression>
| **randomseed** := <numeric expression>
| **maxknotpool** := <numeric expression>
| **save** <symbolic token list>
| **delimiters** <character> <character>
| **setbounds** <picture variable> to <path expression>
| **setgroup** <picture variable> to <path expression>
| **shipout** <picture expression>
| **endinput**
| **input** <string expression>
| **expandafter**
| <addto command>
| <drawing command>

- |
- | <newinternal command>
- | <message command>
- | <mode command>
- | <show command>
- | <tracing command>
- | <scantokens> <string expression>
- | **defineshade** <symbolic token> <shading expression>
- | write <string expression> to <string expression>
- | readfrom <string expression>
- | closefrom <string expression>
- | **readfile** <string expression>
- | readstring
- | restoreclipcolor
- | **savepen**
- | runscript (<string expression> , <numeric primary>)
- | **relax**
- | **pushcurrentpicture**
- | **popcurrentpicture**

<show command>

- show <expression list>
- | showvariable <symbolic token list>
- | showtoken <symbolic token list>
- | showdependencies
- | showstats

<symbolic token list>

- <symbolic token>
- | <symbolic token> , <symbolic token list>

<expression list>

- <expression>
- | <expression list> , <expression>

<addto command>

- addto <picture variable> also <picture expression> <option list>
- | addto <picture variable> contour <path expression> <option list>
- | addto <picture variable> doublepath <path expression> <option list>

<option list>

- <empty>
- | <drawing option> <option list>

<drawing option>

- **withcolor** <color expression> | **withgrey** <numeric expression> | **withgray** <numeric expression>
- | **withrgbcolor** <rgb expression> | **withcmkcolor** <cmk expression> | **withgreyscale** <numeric expression>
- | **withcurvature** <numeric expression>
- | **withlinecap** <numeric expression>
- | **withlinejoin** <numeric expression>
- | **withmiterlimit** <numeric expression>
- | **withmesh** <numeric expression>
- | **withbytemap** <numeric expression>
- | **withstacking** <numeric expression>

- | withoutcolor
- | withnothing
- | withprescript <string expression> | withpostscript <string expression> | withnestedprescript <string expression> | withnested
- | withpen <pen expression>
- | dashed <picture expression>
- | undashed
- | withdashes <numeric expression>
- | withshade <numeric expression> | shaded <shading expression>
- | withproperties <property primary>
- | withtransparency <pair primary>
- | withbytemask <numeric expression> | withbytemasked <numeric expression> | withbyteexpansion <numeric expression>
- | withtransparency (<numeric expression> (,) <numeric expression>)
- | withopacity <numeric expression>
- | <shading expression>
- | onlayer <string expression>
- | withmask <string expression>
- | withtolerance <numeric expression>
- | withnamedstacking <todo>
- | withannotation <todo>
- | withbytemask <numeric expression>
- | withbytemasked <numeric expression>
- | withbyteexpansion <numeric expression>
- | withreduction <todo>
- | withpalette <todo>
- | withproperties <todo>
- | withpattern <picture expression>

<property expression>
 → (drawing option)

<shading expression>

- withshademethod string expression
- | withshadefactor numeric expression
- | withshadedomain pair expression
- | withshadevector pair expression
- | withshaderadius pair expression
- | withshadeorigin pair expression
- | withshadecolors (<color expression> , <color expression>)
- | withshadecenter pair expression
- | withshadecenterone pair expression
- | withshadecentertwo pair expression
- | withshadedirection pair expression
- | withshadestep numeric expression
- | withshadecenterfraction numeric expression
- | withshadecenteronefraction numeric expression
- | withshadecentertwofraction numeric expression
- | withshaderadiusfraction numeric expression
- | withshademethod numeric expression
- | withshadetransform (todo)
- | withshadetransformation (todo)
- | withshadefraction numeric expression
- | withshadecolors (todo)

<drawing command>

→ **draw** <picture expression> <option list>
| <fill type> <path expression> <option list>

<fill type>

→ **fill** | **unfill** | **refill**
| **draw** | **undraw** | **redraw**
| **filldraw** | **drawfill** | **undrawfill** | **unfilldraw**
| **nofill** | **fillup** | **nodraw** | **dodraw** | **dofill**
| **eofill** | **eofillup** | **eoclip** | **enfill**
| **drawdot**
| **drawarrow** | **drawblarrow** | **drawdoublearrows**
| **cutdraw**
| **visualizer**
| **normaldraw** | **normalfill**

<visualizer>

→ **drawboundary** | **drawboundingbox** | **drawboundoptions**
| **drawcontrollines** | **drawcontroloptions** | **drawcontrolpoints**
| **drawlabeloptions** | **drawlineoptions** | **drawoptions**
| **draworigin** | **draworiginoptions**
| **drawpath** | **drawpathonly** | **drawholepath** | **drawpathoptions**
| **drawpoint** | **drawpointlabels** | **drawpointoptions**
| **drawpoints** | **drawwholepath** | **drawboundingbox**
| **visualizeddraw** | **visualizedfill**

<newinternal command>

→ **newinternal** <internal type> <symbolic token list>
| <newinternal> <symbolic token list>

<message command>

→ **errhelp** <string expression>
| **errmessage** <string expression>
| **message** <automatic string expression>
| **report** <automatic string expression>

<mode command>

→ **batchmode**
| **nonstopmode**
| **scrollmode**
| **errorstopmode**
| **silentmode**

<tracing command>

→ **tracingall**
| **loggingall**
| **tracingnone**

<if test>

→ **if** <boolean expression> : <balanced tokens> <alternatives> **fi**

<alternatives>

→ <empty>
| **else** : <balanced tokens>
| **elseif** <boolean expression> (: <balanced tokens> <alternatives>

| **exit** | **exitif** ⟨boolean expression⟩ | **exitunless** ⟨boolean expression⟩
| **break**

⟨loop⟩

→ ⟨loop header⟩ : ⟨loop text⟩ **endfor**

⟨loop header⟩

→ **for** ⟨symbolic token⟩ = ⟨progression⟩
| **for** ⟨symbolic token⟩ = ⟨for list⟩
| **for** ⟨symbolic token⟩ **within** (⟨picture expression⟩ ⟨,⟩ ⟨path expression⟩)
| **forsuffixes** ⟨symbolic token⟩ = ⟨suffix list⟩
| **forever**

⟨progression⟩

→ ⟨numeric expression⟩ **upto** ⟨numeric expression⟩
| ⟨numeric expression⟩ **downto** ⟨numeric expression⟩
| ⟨numeric expression⟩ **step** ⟨numeric expression⟩ **until** ⟨numeric expression⟩
| **range** ⟨numeric expression⟩ **thru** ⟨numeric expression⟩

⟨for list⟩

→ ⟨expression⟩
| ⟨for list⟩ , ⟨expression⟩

⟨suffix list⟩

→ ⟨suffix⟩
| ⟨suffix list⟩ , ⟨suffix⟩

⟨bytemap operations⟩

→ **clipbytemap** (todo)
| **copybytemap** (todo)
| **newbytemap** (todo)
| **reducebytemap** (todo)
| **resetbytemap** (todo)
| **resetbytemaps** (todo)
| **setbyte** (todo)
| **setbytemap** (todo)
| **setbytemapoffset** (todo)
| **setbytemapoptions** (todo)

<property setters>

→ `primitive` | `permanent` | `immutable` | `frozen` | `mutable`